

<b>Voorwoord</b>	<b>4</b>
<b>Bedrijfsinformatie / Coordonnées</b>	<b>5-7</b>
<b>Website - facebook</b>	<b>8-9</b>
<b>Symbolen</b>	<b>10</b>
<b>Gereedschapskoffers - coffrets d'outils</b>	<b>12-16</b>
Gevulde gereedschapskoffer-coffre d'outils	17
Gereedschapskoffers - boîte à outils	18
Gereedschapskoffers - boîte à outils	19-25
Gereedschapswagens 10217-10218 servantas 10217-10218	26-29
Gereedschapswagen-servante Jumbo - toebehoren	32
<b>Service cart - station service</b>	<b>33</b>
<b>Werkbanken - établis</b>	<b>34-35</b>
<b>Ladenkasten - Armoires de rangements</b>	<b>36-37</b>
<b>Gevulde gereedschapswagen - servantas d'talier 10217-10218</b>	<b>38-42</b>
Gevulde gereedschapswagen Jumbo - servante d'atelier Jumbo 10318	43-44
Gevulde gereedschapswagen Maxi tower	45
Gevulde gereedschapswagen - foam-servante d'atelier 10217-10218-10318	46-50
<b>TC TRAYS</b>	<b>52-66</b>
<b>Foamsets</b>	<b>67-84</b>
<b>Doppensets 1/4" - onderdelen - Jeu de douilles - douilles - accessoires 1/4"</b>	<b>86-98</b>
Doppensets 3/8" - onderdelen - ratels - Jeu de douilles - douilles - accessoires 3/8"	101-109
Doppensets 1/2" - onderdelen - Jeu de douilles - accessoires 1/2"	110-130
Doppensets 3/4" - onderdelen - Jeu de douilles - accessoires 3/4"	131-133
Doppenset 1" - onderdelen - Jeu de douilles 1"	134-135
<b>Slagdoppensets 1/2" - Jeu de douilles à choc 1/2"</b>	<b>137-141</b>
Slagdoppensets 3/4" - Jeu de douilles à choc 3/4"	142-145
Slagdoppen 1" - Douilles à choc 1"	146-148
Slagdoppen 1/2" - Douilles à choc 1/2"	149
<b>Gereedschapskoffer- Valise alu</b>	<b>150-151</b>
<b>Steekringsleutels - Clés mixtes mm</b>	<b>154-159</b>
Steeksleutels - clés à fourches	160
Ringsleutels - clés polygonales	161-164
Pijpsleutels - Clés à pipe	165
Open ringsleutelsets - Clés à tuyauter	166
Kniesleutels - clés à douilles articulée	167
Dopsleutels - douilles sur manches	168-169

Verstelbare sleutels - Clés à molette	170-171
Momentsleutels - Clés dynamométrique	173
<b>Schroevendraaiers - Jeu de tournevis</b>	<b>175-181</b>
<b>Bitsen - bitsets - Embouts</b>	<b>182-193</b>
<b>Inbussleutels - Clés mâles</b>	<b>195-199</b>
Haakse torx sleutels - Clés mâles torx	200-201
Inbussleutels op handvat - Clés mâles	202-203
Torx - resistorx	204-205
<b>Tangen - Pinces</b>	<b>207-213</b>
<b>Beitels-doorslag - hamers - Burins - chasse goupilles marteaux</b>	<b>215-217</b>
<b>Tap- en kussenset - Tarrauds &amp; filières</b>	<b>218-220</b>
<b>Snij-meetgereedschap - Mesurer - couper</b>	<b>221-226</b>
<b>Pijptangen - Clés serre-tube</b>	<b>227</b>
<b>Garage equipment</b>	<b>229-235</b>
Vervangen filters olie - Huile	236-243
Ontsteking brandstof - allumage carburant	244-246
Blokkeergereedschap - outils de calage	248-255
Diesel verstuivers - injecteurs diesel	256-257
Motor - moteur	258-263
Remmen - freins	264-269
Wielen - roues	270-273
Aandrijving - suspension & transmission	274
Trekkers . extracteurs	276-280
Truck	282-283
<b>Carrosserie</b>	<b>284-287</b>
<b>Special tools</b>	<b>288-289</b>
<b>Electriciteit 1000v</b>	<b>291-297</b>
<b>Pneumatic tools</b>	<b>302-305</b>
<b>Bagagespanners - Sangles</b>	<b>306</b>
<b>Bankschroeven - Etaux</b>	<b>307</b>
<b>Takels - Palans - winches</b>	<b>308-311</b>
<b>Divers</b>	<b>312-315</b>
<b>Catalogi</b>	<b>317</b>
<b>Inhoud</b>	<b>318</b>

## **Wij heten u van harte welkom in onze nieuwe Zasco catalogus 2018-2019**

ZASCO is een im-exporteur van professionele gereedschappen voor de vakhandel actief op de Benelux markt.

In België is ZASCO exclusief verdeler van het merk Force, een producent van gevulde gereedschapswagens en handgereedschap, toegespitst naar de automobielsector.

Ons gamma wordt verder aangevuld met divers gereedschap zoals gereedschapsets, diverse tangen, hamers, tappen - en kussensets, winches, automotive tools, takels, bagagespanners, werkhandschoenen, verfspuiten, pneumatische tools, bankschroeven, snijgereedschap

Wij wensen U alvast een boeiende ontdekkingstocht toe en hopen u binnenkort te mogen verwelkomen in de wereld van Zasco.

**ZASCO Tools & Equipment is uw beste professionele partner als het om gereedschap gaat.**



<b>MAATSCHAPPELIJKE ZETEL</b>	Wassenhovestraat 3 - 9620 Zottegem
<b>TELEFOON</b>	09 360 01 52 – bestellijn : 09 367 49 95
<b>FAX</b>	09 361 36 30
<b>E-MAIL</b>	info@zasco.be
<b>WEBSITE</b>	http://www.zasco.be
<b>BANKREKENING</b>	KBC IBAN BE34 4444 6567 8190 BIC KREDBEBB BNP PARIBAS IBAN BE77 2850 3790 8942 BIC GEBABEBB
<b>ONDERNEMINGSNUMMER</b>	BE 0432.389.277
<b>OPENINGSUREN</b>	Open van 8u tot 12u en van 13u tot 17u (Vrijdag tot 15u)

### ALGEMENE VOORWAARDEN

#### **GARANTIES**

Op alle gereedschappen is er 1 jaar garantie (of meer indien duidelijk vermeld) tegen fabricatie fouten. Op FORCE gereedschap **onbeperkte** garantie. Garanties die slijtage vertonen of ondeskundig gebruikt werden vallen **NIET** onder garantie.

#### **PRIJSZETTING**

Al onze prijzen in deze catalogus zijn bruto exclusief BTW, af magazijn en in Euro. Aangezien de prijzen vermeld in deze tarief onderhevig zijn aan schommelingen in kost van materiaal en andere, kunnen er steeds prijswijzigingen doorgevoerd worden. Gelieve ons vooraf te raadplegen.

De producten kunnen zonder voorafgaande mededeling aangepast of gewijzigd worden. De afbeelding zijn louter indicatief, de producten kunnen afwijken van de in de catalogus vermelde afbeeldingen.

#### **VERKOOPSVORWAARDEN**

Alleen geldig voor leveringen binnen België.

#### **LEVERINGSTERMIJN**

Behoudens onvoorziene omstandigheden worden de bestellingen verzendingsklaar gemaakt binnen de drie werkdagen na ontvangst of worden door onze chauffeur afgeleverd (mits een kost van € 5 voor bestellingen onder de € 500).

#### **LEVERINGSCONDITIES**

Franco vanaf € 500 netto in België.

Bij facturen onder € 20 wordt € 10 administratiekosten aangerekend.

#### **TERUGNAMES**

Geleverde goederen worden slechts teruggenomen mits uitdrukkelijk akkoord door onze commerciële dienst én mits de goederen zich onbeschadigd en in de originele verpakking bevinden. Bij terugname van goederen wordt er steeds 10% afgetrokken op de aankoopprijs.

#### **BETALINGSCONDITIES**

Onze facturen zijn betaalbaar contant binnen 8 dagen met 2% disconto, ofwel op 30 dagen netto.

De goederen blijven eigendom van Zasco tot alle betalingen volledig voldaan zijn aan Zasco.



### **Bienvenue dans notre nouveau catalogue 2018-2019**

ZASCO est une société d'import - et export d'outillage professionnel pour la vente aux professionnels. Nous sommes active sur le marché du Benelux.

En Belgique Zasco est le distributeur officiel pour la marque FORCE, fabricant de servantes complètes et d'outillage à main dans le domaine de l'automobile.

Notre gamme d'outillage se complète d'autre matériels divers :  
des marteaux, tarauds et filières,  
sangles, treuils, pistolets de peinture,  
matériels pneumatique, chandelles,  
...

Prenez le temps de consulter notre catalogue et avez-vous des questions, n'hésitez pas à nous contacter. Nous vous contracterons le plus vite possible.

**ZASCO Tools & Equipement votre meilleur partenaire quand il s'agit d'outillage**



**Siège social** Wassenhovestraat 3 - 9620 Zottegem  
**Telephone** 09 360 01 52 – 09 367 49 95  
**Fax** 09 361 36 30  
**E-Mail** info@zasco.be  
**Website** http://www.zasco.be

**Compte de banque** KBC 444-4656781-90 IBAN BE34 4444 6567 8190  
BIC KREDBEBB  
BNP PARIBAS 285-0379089-42 IBAN BE77 2850 3790 8942  
BIC GEBABEBB

**Numero d'entreprise** BE 0432.389.277

**Heures ouverture** 8u -12u 13u - 17u  
(Vendredi 15u)

## CONDITIONS DE VENTE

### GARANTIES

Il y a un ans garantie sur tous les outils. Les outils FORCE sont garantis à vie.

Retours des demande de garanties : les demandes de garanties doivent nous parvenir ou par le réprésentant ou par notre propre transport. Veuillez noter que nous refuserons tous les demandes de garanties contre remboursements d'un autre transporteur.

### REMISES ET PRIX

Tous les prix de ce catalogue s'entendent brut et hors TVA. Etant donné que les prix repris dans le tarif dépendent des fluctuations du cours de US dollar, ils sont constamment susceptible d'être modifiés. Veuillez nous consulter à l'avance. Ses remises sont à convenir au cas par cas.

### CONDITIONS DE VENTE

Uniquement valable pour les livraisons en Belgique.

### CONDITIONS DE LIVRAISON

Après réception, les commandes sont prêtes pour enlèvement ou livrée par notre chauffeur dans un délai de 3 jours, sauf imprévu.

Livraison franco à partir de € 500 - frais de facturation 10 € par achat de -20€

### REPRISES

Les marchandises livrées ne seront reprises qu'après accord formel de la société et si les marchandises seront intact et dans l'emballage originales. Nous déduisons toujours 10 % pour les retours.

### CONDITIONS DE PAIEMENT

Nos factures sont payables ou comptant endéant les 8 jours avec 2% d'escompte ou à 30 jours net  
La marchandise reste la propriété de Zasco en attendant le paiement.

LEVERANCIERS →

### Onze site

Boordevol Tools & equipment voor de professional. Promo's, info en vooral een handige webshop waar je online 24/24 terecht kan voor uw bestellingen. Surf vlug naar [www.zasco.be](http://www.zasco.be) en registreer je nu!

### Notre site

Plein avec tools & equipment pour le professional? Promos, info et surtout uw webshop pratique pour toutes vos commandes online 24/24. Enregistrez-vous vite sur [www.zasco.be](http://www.zasco.be)!



**ZASCO** home producten • promoties • nieuws • contact • catalogi artikelnummer of trefwoord

**Zasco Tools & Equipment**  
uw beste partner als het om gereedschap gaat

ZASCO cv.b.a. - Wassenhovestraat 3 - Industriezone II - 9620 Zottegem - info@zasco.be - t +32 9 360 01 52 - f +32 9 361 36 30



Volg ons op facebook en blijf op de hoogte van onze acties, promoties, wedstrijden, ...

Suis nous sur Facebook et restez informé de nos actions, promotions, des concours ...

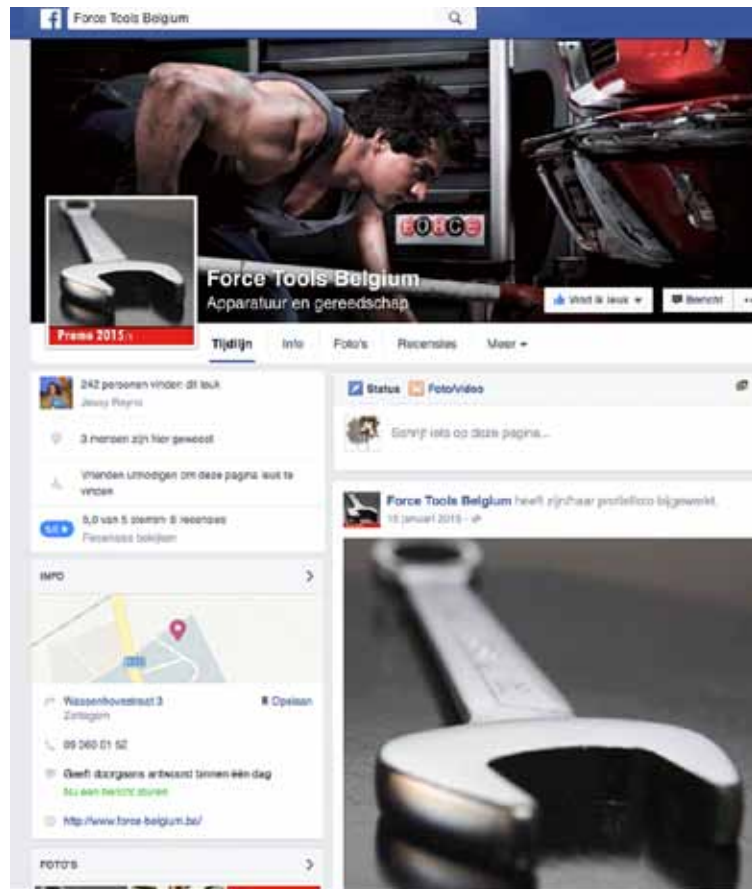

	6 kant - 6 pans
	12 kant - 12 pans
	Torx inwendig
	XZN dop inwendig
	plat
	philips
	pozidrive
	hexagonales
	hexagonales met kogelkop
	Torx
	Resistorx
	XZN (12 tanden)
	Ribe
	inch

## GARANTIES "Force"

Force gereedschappen worden voor professioneel en intensief gebruik, zowel voor onderhoud als reparatie, ontwikkeld en geproduceerd volgens de normen en is voorzien van "levenslange" garantie, welke inhoudt dat het defecte gereedschap kosteloos zal vervangen worden. Deze garantie dekt alle handgereedschappen indien deze op een normale en correcte manier zijn gebruikt.

De garantie dekt alle handgereedschappen bij een defect indien deze een gevolg is van een fabricagefout.

De garantie vervalt indien ze slijtage vertonen, van bv bitsen, zaagbladen, cuttermessen, vijlen, hamers etc.

Of verkeerd en/of ondeskundig gebruik, schade die wordt veroorzaakt aan het gereedschap zoals brand, water, verkeerde toepassing. Ieder gereedschap moet compleet retour komen.

## GARANTIES "Force"

Les outils de Force ont été développés pour utilisation professionnel et intensive, à la fois pour l'entretien et la réparation suivant les normes et ont une garantie à vie. Ce garantie couvre tous les outils qui ont été utiliser d'un façon correct.

La garantie couvre tous les outils défectueux à cause d'une faute de fabrication.

La garantie est nulle si elles présentant une usure de p.e. embouts, lames, cuteur, marteaux etc.

Ou en abus et/ou uneutilisation incorrecte. Tous les outils doivent nous être remis complet.





# Discover the Enchantment...



Gereedschapskoffers - coffrets d'outils

12.....



Gereedschapskoffers gevuld - coffrets d'outils

16



Gereedschapswagens - servantes

26



Accessoires gereedschapswagens -accessoires servantes

28



Werkbank - établi

34



Ladenkasten - armoires

36



Gereedschapswagens gevuld met TC modules - servantes avec outils

38

Gereedschapswagens gevuld met foam modules - servantes avec foam

46



TC Trays

51

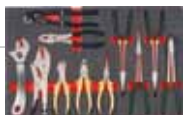

Foam sets 10225-10217-10218

67

Foam sets Jumbo 10318

77

## FOR 50230

### Gereedschapstas in stof (leeg)

- met draagriem

### Caisse à outils textile (vide)

- sangle pour transporter un niveau

Afm/dim/Dim	L53.50	B25.80	H22.50
-------------	--------	--------	--------



## FOR 50234

### Gereedschapskoffer op wielen

- afsluitbaar met sleutel

### Valise avec trolley

- fermeture avec clés

Totale Afm/dim	L45cm	B33cm	H15cm
gewicht/poids	3.3kg		



## FOR 50223S

### Gereedschapskoffer 3 laden

- zijdelingse handgrepen + handvat bovenaan
- 2 sluitingen
- 3 kogelgelagerde laden 100% uitschuifbaar

### Coffre à outils 3 tiroirs

- 3 tiroirs sur roulements à billes
- 2 poignées latérales en acier

Totale Afm/dim	L55.5cm	B24cm	H28cm
gewicht/poids	12.5kg		
Hoogte laden			H 4.5cm





## FOR 50235

### Gereedschapskoffer met 5 vakken

- groot opbergvolume
  - afsluitbaar met hangslot
  - electrostatisch gepoedercoated
- Gewicht 8.2 kg

### Coffre d'outils à 5 compartiments

- fermeture par cadenas (non fourni)
  - 5 compartiments
- poids 8.2 kg



## FOR 50223C

## FOR 50223R

### Gereedschapskoffer 3 laden

- 3 laden (12 TC modules 4 per lade)
- kogelgelagerd & centrale vergrendeling met 2 sleutels
- laden 100% uitschuifbaar
- anti blokkeersysteem 1 lade tegelijk open
- zijdelings dubbele handgrepen
- stapelbaar op gereedschapswagen 10217 & 10218
- alle laden voorzien van rubbermatten
- werkblad met dikke rubbermat

### Coffre d'outils à 3 tiroirs

- 3 tiroirs sur roulements à billes
- fermeture centralisée avec 2 clés pliable
- système de blocage de tiroirs
- plan de travail caoutchouc
- 2 poignée latéraux en acier

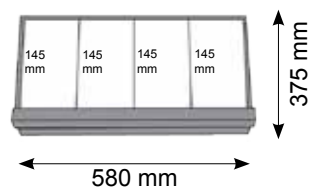

Afm/dim	L 70cm	B 47 cm	H 34 cm
Binnen maten laden/tiroirs	L 58 cm	B 37.5 cm	H 6 cm
gewicht/poids	27.4 kg		

## FOR TBC123B

### Gereedschapskoffer met 5 vakken

- groot opbergvolume
- afsluitbaar met hangslot

### Coffre d'outils à 5 compartiments

- fermeture par cadenas (non fourni)
- 5 compartiments

Totale Afm/dim	L52.5cm	B20cm	H19.5cm
gewicht/poids	3.8kg		



## FOR 10225C

### FOR 10225R

#### Gereedschapskoffer 5 laden

- 5 laden (20 TC modules - 4 per lade)
- kogelgelagerd & centrale vergrendeling met 2 sleutels
- laden 100% uitschuifbaar
- anti blokkeersysteem 1 lade tegelijk open
- stapelbaar op gereedschapswagen 10217 & 10218
- zijdelingse handvaten
- alle laden voorzien van rubbermatten
- werkblad met rubbermat

#### Coffre d'outils 5 tiroirs

- 5 tiroirs sur roulements à billes
- fermeture centralisée avec 2 clés pliable
- système de blocage de tiroirs
- plan de travail caoutchouc
- 2 poignée latéraux en acier

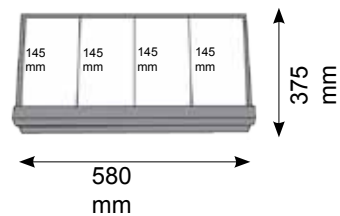

Afm/dim	L 69 cm	B 46 cm	H 49 cm
Binnenmaten laden/tiroirs	L 58 cm	B 37.5 cm	H 6cm
gewicht/poids	38.7 kg		

**FOR 10323C**  
**FOR 10323R**



**Gereedschapskoffer 3 laden voor Jumbo**

- 3 laden (18 TC modules - 6 per lade)
- kogelgelagerd & centrale vergrendeling met 2 sleutels
- laden 100% uitschuifbaar
- anti blokkeersysteem 1 lade tegelijk open
- stapelbaar op gereedschapswagen **10318**
- zijdelingse handvaten
- alle laden voorzien van rubbermatten
- werkblad met rubbermat

**Coffre d'outils 3 tiroirs pour Jumbo**

- 3 tiroirs sur roulements à billes
- fermeture centralisée avec 2 clés pliable
- système de blocage de tiroirs
- plan de travail caoutchouc
- 2 poignée latéraux en acier

Afm/dim	L 95 cm	B 50 cm	H 36 cm
Binnenmaten laden/tiroirs	L 75cm	B 43.5 cm	H 6cm
gewicht/poids	37.8 kg		

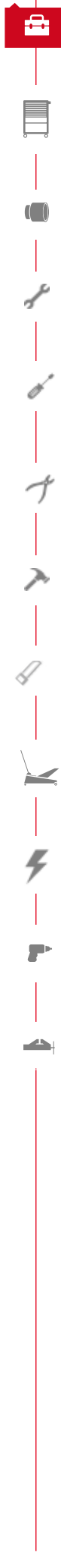
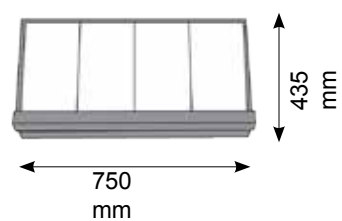

## FOR 50231-33

### Notebook bag 34 delig

#### Trousse de bord 34 pcs

Afm/dim	L38.5	B24	H5cm
gewicht/poids			

<b>611B160</b>	universele tang, pince universelle 160 mm
<b>612B160</b>	kniptang, pince coupante 160 mm
<b>613B250</b>	waterpomptang, pince multiprise 250 mm
<b>616B16</b>	hamer, marteau
<b>649200</b>	verstelbare moersleutel, clé à molette 200 mm
<b>7111</b>	schroevendraaier, tournevis PH1 80 mm L
<b>7112</b>	schroevendraaier, tournevis PH2 100 mm L
<b>71304</b>	schroevendraaier, tournevis plat 4 mm 100 mm L
<b>713055</b>	schroevendraaier, tournevis plat 5.5 mm 125 mm L
<b>713065</b>	schroevendraaier, tournevis plat 6.5 mm 150 mm L
<b>755</b> <b>08...19</b>	steekringsleutels, clés mixtes 8-10-11-12-13-14-17-19 mm
<b>5072F</b>	inbusset, jeu de clés allen 2.5-3-4-5-6-8-10 mm
<b>5083F</b>	torx set T9-T10-T15-T20-T25-T27-T30-T40
<b>9U3001</b>	



## FOR 50235-88

### Gereedschapskoffer 5 delig gevuld 1000v

- gereedschap 88 delig
- metalen koffer

### Coffre d'outils avec 88 pcs d'outils 1000v

- coffre metal
- pour l'électronique et maintenance générale

Afm/dim	L 535 mm	B 258 mm	H 225 mm
gewicht/poids			

## FOR C5153

Steekringsleutels 15 stuks, clés mixtes 15 pcs

8-10-11-12-13-14-15-16-17-18-19-21-22-23-24 mm

## FOR C4482

1/4" doppen 525.....	douilles 6p 4-4.5-5-5.5-6-7-8-9-10-11-12 mm
1/2" doppen 545...	10-11-12-13-14-15-16-17-18-19-21-22-24
8044050-8044150	verlengstuk, rallonges 50 mm & 150 mm
80521/80541	kniegewricht, cardan 1/4" + 1/2"
81225	magneet, aimant
81022	bit houder 1/4" x 1/4"
802223	ratel, cliquet 1/4"
8032115	wringstaaf, manche en T 1/4"
8143	schroevendraaier handvat, manche
80242	ratel, cliquet 1/2"
8034250	wringstaaf, manche en T 1/2"
21111	bitset 11 delig, boîte de 11 embouts

## FOR C50412

6903180	kombinatietang, pince universelle 1000v 180 mm
6904160	bektang, pince à becs long 1000v 160 mm
6905160	kniptang, pince coupante 1000v 160 mm

## FOR C20913

7111N	PH1 (80 mm L)
7112N	PH2 (100 mm L)
713024N	2.4 (75 mm L)
71304N	4 (100 mm L)
713055N	5.5 (125 mm L)
713065N	6.5 (150 mm L)
88403	voltage tester 80-250v AC
5096P8	meter 5m, mètre à ruban 5m
68601	led lampje, lumière

## FOR C51220

616300	hamer, marteau 300 gr
616A400	nylon hamer, marteau nylon 400 gr
6907250	waterpomptang, pince multiprise 1000v 250 mm
614250	vise grip tang, pince grip 250 mm
649200C	moersleutel, clé à molette 200 mm
66302	mini hakzaag, scie mini
5055P3	zaagblad, lame
6982	schaar, ciseau de technicien 145 mm
5055P4	cuttermes, couteau
60212150	beitel, burin 12 (150 mm L)
60219180	beitel, burin 19 (180 mm L)





## FOR 50235-101

Gereedschapskoffer 5 delig gevuld met gereedschap 101 delig

*Coffre d'outils avec 101 pcs outils*

- coffre metal à 5 étages

Afm/dim	L 535 mm	B 258 mm	H 225 mm
gewicht/poids	18.23 kg		



## FOR C5153

Steekringsleutels 15 stuks, clés mixtes 15 pcs

8-10-11-12-13-14-15-16-17-18-19-21-22-23-24 mm



## FOR C5142

613B250	waterpomptang, pince multiprise 250 mm
610B200	lange bektang, pince à becs long 200 mm
611B175	universele tang, pince universelle 175 mm
612B175	kniptang, pince coupante 175 mm
5102	inbusset 1.27 tot 10 mm, clés allen



## FOR C21114

7110-7111-7112	PH0-PH1-PH2
7111S-7112S	PH1 - PH2 (25 mm L)
71303 - 71304	3 mm - 4 mm
713055-713065	5.5 mm - 6.5 mm
713055S-713065S	5.5 mm - 6.5 mm (25 mm L)



## FOR C4482

1/4" doppen 525.....	douilles 6p 4-4.5-5-5.5-6-7-8-9-10-11-12 mm
1/2" doppen 545...	10-11-12-13-14-15-16-17-18-19-21-22-24
8044050-8044150	verlengstuk, rallonges 50 mm & 150 mm
80521/80541	kniegewricht, cardan 1/4" + 1/2"
81225	magneet, aimant
81022	bit houder 1/4" x 1/4"
802223	ratel, cliquet 1/4"
8032115	wringstaaf, manche en T 1/4"
8143	schroevendraaier handvat, manche
80242	ratel, cliquet 1/2"
8034250	wringstaaf, manche en T 1/2"
21111	bitset 11 delig, boîte de 11 embouts



## FOR C5136

5055P4	1 cuttermes, couteau
5096P8	meter 5m, mètre à ruban
60215180Q	beitel, burin 15 (180 mm L)
604419Q/6045200Q	puntbeitel, burin pointeau 4 (190 mm L) 5 (200 mm L)
6046210Q	puntbeitel, burin pointeau 6 (210 mm L)
614250	vise grip tang, pince grip 250 mm
616300	hamer 300 gr, marteau
616400	rubber hamer 400 gr, marteau caoutchouc
649250A	moersleutel 250 mm, clé à molette
66302	mini hakzaag + reservezaagjes /scie



## FOR 50235-187

Gereedschapskoffer 5 delig gevuld met gereedschap 187 delig

Coffre d'outils avec 187 pcs outils

- coffre metal à 5 étages



Afm/dim	L 535 mm	B 258 mm	H 225 mm
gewicht/poids	21 kg		

1/4" doppen 525.....	douilles 6p 4-4.5-5-5.5-6-7-8-9-10-11-12-13 mm
1/4" lange doppen	8-10-12
1/4" bits op dop	PH.0-PH.1-PH.2-PH3-PZ1-PZ2
1/4" bits op dop plat	4-5.5-6-5-7
1/4" inbus	3-4-5-6-7-8-10
1/4" torx	T8-T10-T15-T20-T25-T27-T30
1/4" resistorx	T8H-T10H-T15H-T20H-T25H-T27H-T30H-T40H
8044050-8044100	verlengstuk, rallonges 50 mm & 100 mm
80521/80541	kniegewricht, cardan 1/4" + 1/2"
8143	1/4" spinner 150mmL
8032115	1/4" wringstaaf T 115mmL
81022	Bit houder 1/4" x 1/4"
2331A	veiligheidsbitset 33dlg 1/4"
21013	vijf ster bitset 10dlg 1/4"
5457713...19	1/2" lange doppen 13-17-19mm
80228	ratel, cliquet 1/4"

1/2" doppen 545...	10-11-12-13-14-15-16-17-18-19-20-21-22-23-24-27-30-32
8044125-8044250	verlengstuk, rallonges 125 mm & 250 mm
80541	kniegewricht, cardan 1/2"
80634	adapter vr verlengstuk 3/8" x 1/2"
807416-807420.6	1/2" bougiedop 16- 20.6mm
80248	1/2" ratel 72tanden
34605540....55	1/2" torx doppen T40-T45-T50-T55

Steekringsleutels , clés mixtes	
6-7-8-9-10-11-12-13-14-15-16-17-18-19mm	
5116LB inbus set 11dlg	

616300	hamer 300gr, marteau
610B200	lange bektang, pince à becs long 200 mm
611B175	universele tang, pince universelle 175 mm
612B175	kniptang, pince coupante 175 mm
68021	mes
68601	LEd lamp (360° draaibaar)

613B250	waterpomptang
614250	vise grip 250mm
649250	moersleutel 250mm
609ABC-609ASO	circlipstangen
616A400	hamer 400gr PU + nylon
60212150 -6074185	beitel 150mmL 12 - center punt 185mmL 4
50613	set doorslagen 6 dlg

7111-7113	PH1-PH3
7112M	PH2 hamer schroevendraaier
7111S-7112S	PH1 - PH2 (25 mm L)
71303 -71303S- 71304	3 mm - 3.5 mm -4 mm
71305S-71308	5.5 mm - 8mm
713065M	6.5 hamer schroevendraaier
713055S-713065S	5.5 mm - 6.5 mm (25 mm L)





## FOR 50230-95

Gereedschapstas met schouderriem gevuld met gereedschap 95 delig

*Coffre d'outils avec 95 pcs d'outils*

Afm/dim	L	B	H
gewicht/poids	10.8 kg		



<b>610B160</b>	lange bektang, pince à becs long 160 mm
<b>612B160</b>	kniptang, pince coupante 160 mm
<b>611B160</b>	universele tang, pince universelle 160 mm
<b>5102</b>	inbussleutelset, clés allen 1.27-10 mm
<b>5055P4</b>	cuttermes, couteau
<b>613200</b>	waterpomptang, pince multiprise 200 mm
<b>614175</b>	vise grip tang, pince grip 175 mm
<b>649200C</b>	verstelbare moersleutel, clé à molette 200 mm
<b>5096P803</b>	meter 3m, mètre à ruban
<b>755.....</b>	steekringsleutel, clés mixtes 8 tot 24 mm
<b>6982</b>	schaar, ciseau de technicien
<b>7111N</b>	schroevendraaier, tournevis 1000v PH1
<b>71304N</b>	platte schroevendraaier, tournevis plat 4 mm 1000v
<b>88407</b>	tester, testeur
<b>7111M</b>	hamer schroevendraaier, tournevis à frapper PH1
<b>7112M</b>	hamer schroevendraaier, tournevis à frapper PH2

<b>71308M</b>	hamer schroevendraaier, tournevis à frapper 8 mm
<b>713055M</b>	hamer schroevendraaier, tournevis à frapper 5.5 mm
<b>713065M</b>	hamer schroevendraaier, tournevis à frapper 6.5 mm
<b>71303A</b>	schroevendraaier, tournevis 3 mm
<b>71304A</b>	schroevendraaier, tournevis 4 mm
<b>7110A</b>	schroevendraaier, tournevis PH0
<b>617F</b>	3 in 1 magneet met spiegel, aimant avec miroir
<b>2421F</b>	doppenset, jeu de douilles 1/4" 42 delig
<b>616A400</b>	hamer, marteau 400 gr
<b>616F032</b>	bank hamer, marteau tête rivoir
<b>6044190</b>	doorslag, chasse goupilles 4 mm (190 mm L)
<b>6074185</b>	center punt, pointeau 4 (185 mm L)
<b>60212150</b>	beitel, burin 150 mm L
<b>603150</b>	kapbeitel, bedane 150 mm L
<b>6063185</b>	puntslag, burin pointeau 3 185 mm L
<b>66301</b>	hakzaag, scie

## FOR 50234-107

Gereedschapskoffer ABS op wielen gevuld met gereedschap 107 delig

Valise porte-outils, poignée télescopique et roues avec 107 outils

Afm/dim	L 450 mm	B 330 mm	H 150 mm
gewicht/poids	12.9 kg		



6905160	kniptang, pince coupante 1000v 160 mm
6903160	kombinatietang, pince universelle 1000v 160 mm
6904160	lange bektang, pince à becs long 1000v 160 mm
6907250	waterpomptang, pince multiprise 1000v 250 mm
6912160	striptang, pince à dénuder 1000v
649250A	regelbare moersleutel, clé à molette 1000v 250 mm



614250	griptang, pince grip
5055P4	cuttermes, couteau
5115	11 delig steekringsleutelset, clés mixtes 8-22 mm
5054	5 delig beitset, jeu de burins
5102	10 delig inbussleutelset, jeu de clés mâle 1.27 tot 10 mm



7111N	PH1 1000v
7112N	PH2 1000v
71303N	3 mm 1000v
71304N	4 mm 1000v
713055N	5.5 mm 1000v
713065N	6.5 mm 1000v
7112AS	PH1 (25 mm)
713065AS	6.5 mm (25 mm)
7111A	PH1
7112A	PH2
7113A	PH3
2125P1	tester, testeur



2421BF	doppenset, jeu de douilles 1/4" 42 delig
616300	hamer, marteau 300 gr
616400	rubber hamer, marteau coutchouc
66302	mini hakzaag, scie
5096P8	meter 5m, mètre à ruban
2125P1	circuit tester, détecteur de tension
4106	doppenset op rail, jeu de douilles 10 tot 24 mm
80242	ratel, cliquet 1/2"
68604	dynamo lamp
5096P2	center punt, pointeau



## FOR 50223S103

**Gereedschapskoffer 3 laden gevuld met gereedschap 103 delig**

- metalen koffer, coffre métal

**Coffre d'outils 3 tiroirs 103 pcs**

- coffre métal



Afm/dim	L 555 mm	B 240 mm	H 280 mm
gewicht/poids	21.4 kg		

## FOR F4721

**1/4"-1/2" doppenassortiment 72 delig + bits, ass. douilles 72 pcs**

<b>12k doppen 1/4"</b>	4-4.5-5-5.5-6-7-8-9-10-11-12-13 mm 12pans
<b>lange doppen</b>	8-10-13 mm 1/4" - 17-19-21 mm 1/2"
<b>12k doppen 1/2"</b>	14-15-16-17-18-19-20-21-22-24-27-30-32 mm 12pans
<b>80521 / 80541</b>	kniegewricht, cardan universelle 1/4" - 1/2"
<b>802215/80243</b>	1/4" ratel, cliquet 1/2" ratel
<b>8032115</b>	1/4" wringstaaf, manche en T
<b>8042050</b>	1/4" verlengstuk, rallonge 50 mm
<b>8044075/8044250</b>	1/2" verlengstuk, rallonges 75 mm & 250 mm
<b>81022</b>	bit houder, porte embouts
<b>81022M</b>	magneet bit houder, porte embouts magnétique
<b>8143</b>	steekhecht, manche tournevis
<b>8044125W</b>	1/2" verlengstuk, rallonge 125 mm
<b>80634</b>	adapter voor verlengstuk, adaptateur pour rallonge



## FOR F20914

**Schroevendraaierset 9 delig, module de 9 tournevis**

<b>7111</b>	PH1
<b>7112</b>	PH2
<b>7113</b>	PH3
<b>7112S</b>	PH 2 (25 mm L)
<b>71304</b>	4 mm
<b>713055</b>	5.5 mm
<b>713065</b>	6.5 mm
<b>71308</b>	8 mm
<b>713065S</b>	6.5 mm (25 mm L)



## FOR F51210FV

**Flexibele ratelsleutelset 12 delig, module de 12 clés mixtes à cliquet flex**

<b>757 08....19</b>	8-9-10-11-12-13-14-15-16-17-18-19 mm
---------------------	--------------------------------------



## FOR F51012

**Kombinatieset 10 delig, modules de combination 10 pcs**

<b>60212150/603150</b>	beitel, burin 12 mm (150 mm L) - kapbeitel 150 mm
<b>6074185</b>	center punt, pointeau 4 (185 mm L)
<b>6043150</b>	doorslag, chasse goupil. 3 mm(150 mm L)
<b>6044190</b>	4 mm (190 mm L)
<b>613B250</b>	waterpomptang, pince multiprise 250 mm
<b>610B200</b>	lange bektang, pince à becs long 200 mm
<b>611B175</b>	kombinatietang, pince universelles 175 mm
<b>612B175</b>	kniptang, pince coupante 175 mm
<b>616200</b>	hamer, marteau 200 gr





## FOR 50223S116-5

Gereedschapskoffer 3 laden gevuld met gereedschap 116 delig

- metalen koffer,

*Coffre d'outils 3 tiroirs 116 pcs*

- coffre metal



Afm/dim	L 555 mm	B 240 mm	H 280 mm
gewicht/poids	21.4 kg		

## FOR F4721 5

1/4"-1/2" doppenassortiment 72 delig + bits, ass. douilles 72 pcs

6k doppen 1/4"	4-4.5-5-5.5-6-7-8-9-10-11-12-13 mm 6 pans
lange doppen	8-10-13 mm 1/4" - 17-19-21 mm 1/2"
6k doppen 1/2"	14-15-16-17-18-19-20-21-22-24-27-30-32 mm 6 pans
80521 / 80541	kniegewricht, cardan universel 1/4" - 1/2"
802215/80243	1/4" ratel, cliquet 1/2" ratel
8032115	1/4" wringstaaf, manche en T
8042050	1/4" verlengstuk, rallonge 50 mm
8044075/8044250	1/2" verlengstuk, rallonges 75 mm & 250 mm
81022	bit houder, porte embouts
81022M	magneet bit houder, porte embouts magnétique
8143	steekhecht, manche tournevis
8044125W	1/2" verlengstuk, rallonge 125 mm
80634	adapter voor verlengstuk, adaptateur pour rallonge



## FOR F20914

Schroevendraaierset 9 delig, module de 9 tournevis

7111	PH1
7112	PH2
7113	PH3
7112S	PH 2 (25 mm L)
71304	4 mm
713055	5.5 mm
713065	6.5 mm
71308	8 mm
713065S	6.5 mm (25 mm L)



## FOR F5252

Steekringsleutels + inbussleutels 25 delig, module 25 clés mixtes

755 serie	6-7-8-9-10-11-12-13-14-15-16-17-18-19-22-24 mm
5093LB	765 serie 1.5-2-2.5-3-4-5-6-8-10 mm



## FOR F51012

Kombinatieset 10 delig, module de combination 10 pcs

60212150/603150	beitel, burin 12 mm (150 mm L) - kapbeitel 150 mm
6074185	center punt, pointeau 4 (185 mm L)
6043150	doorslag, chasse goupil. 3 mm(150 mm L)
6044190	4 mm (190 mm L)
613B250	waterpomptang, pince multiprise 250 mm
610B200	lange bektang, pince à becs long 200 mm
611B175	kombinatietang, pince universelles 175 mm
612B175	kniptang, pince coupante 175 mm
616200	hamer, marteau 200 gr



**FOR 10225C247**

**FOR 10225R247**

**Gereedschapskoffer 5 laden  
gevuld met gereedschap 247 delig**

- 4 laden gevuld, 14 modules

**Coffre d'outils 5 tiroirs 247 pcs**

- 4 tiroirs avec outils, 14 modules



<b>Afm/dim</b>	L 690 mm	B 460 mm	H 490 mm
<b>gewicht/poids</b>	65.2 kg		

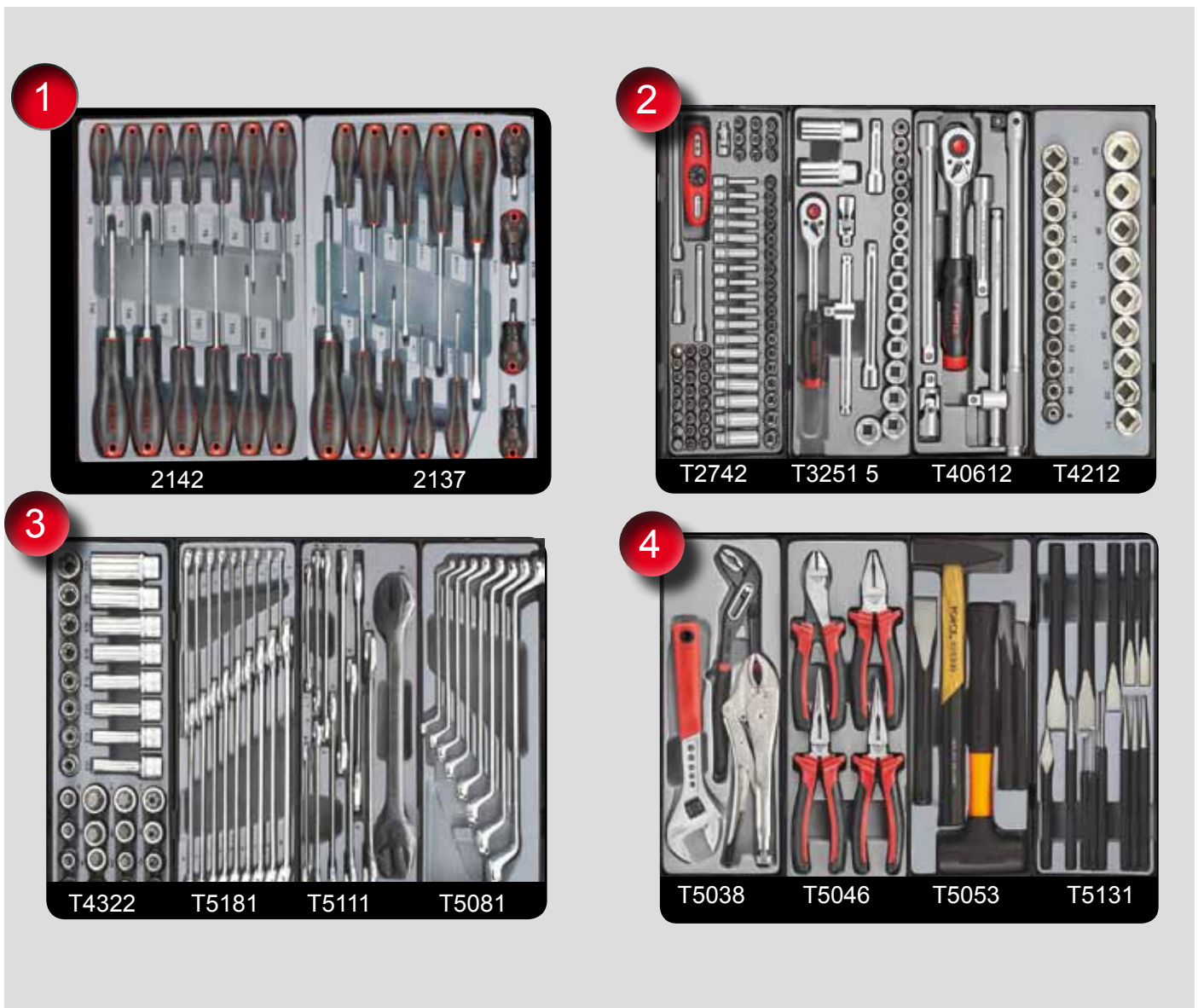

## FOR 10225C181

## FOR 10225R181

**Gereedschapskoffer 5 laden**  
 gevuld met gereedschap 181 delig

- 4 laden gevuld, 4 foams

**Coffre d'outils 5 tiroirs 181 pcs**

- 4 tiroirs avec outils, 4 foams

<b>Afm/dim</b>	L 690 mm	B 460 mm	H 490 mm
<b>gewicht/poids</b>	65.2 kg		



1

FOR F2262 Schroevendraaierset 26 delig



2

FOR F51217 tangenset 12 delig



3

FOR F41083 Assortiment 108 delig

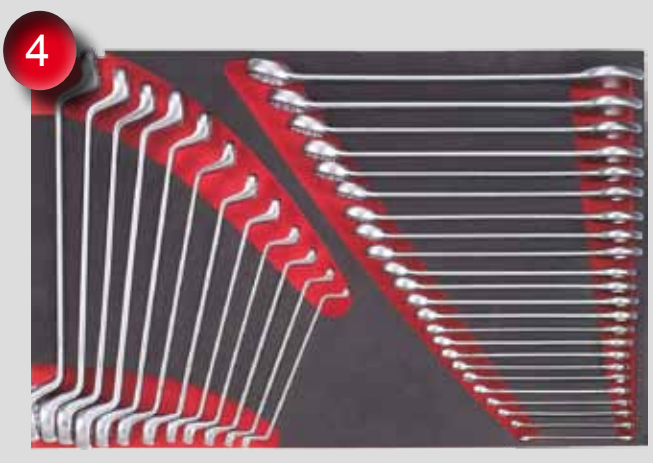

4

FOR F5351 Sleutelset 35 delig



## Practical Series



### Professionele gereedschapswagens van hoge kwaliteit

- laden 100% uitschuifbaar
- kogelgelagerde geleiders
- ABS topblad met 2 ingebouwde handgrepen
- zijbakje voor spuitbussen
- stootranden op de 4 hoeken
- grote wieldiameter (130 mm) makkelijk verplaatsbaar
- 2 vaste wielen & 2 zwenkwielen met rem
- beveiliging tegen gelijktijdig openen van meerdere laden
- centrale vergrendeling met 2 plooibare sleutels
- rubber bescherming op alle ladenbodems
- draagkracht per lade 40kg, totale statische belasting van 600kg

### Servantes Professionèle

- système d'ouverture positionnée sur toute la longueur du tiroirs
- tiroirs s'ouvrent 100%
- sur roulements à billes
- plan de travail en ABS avec 2 poignées intégrées
- support façons
- pare chocs sur les 4 angles de la servante
- 4 roues extra larges (130 mm)
- verrouillage centrale avec 2 clés, serrure à clé articulée
- tiroirs avec système de blocage
- fonds des tiroirs protégés par un tapis en caoutchouc



## FOR 10217R

## FOR 10217C

## FOR 10217A

## FOR 10217B



### Gereedschapswagen 7 laden

- Afm/dimeting laden : 580 mm x 375 mm
- 6 laden - 60 mm hoog
- 2 laden - 120 mm hoog
- 4 wielen 130 mm : 2 vaste en 2 zwenkwielen waarvan 2 met rem
- kleuren : rood, zwart, blauw, oranje
- geleverd met 1 spuitbushouder

### Servante 7 tiroirs

- dimensions tiroirs : 580 mm x 375 mm
- tiroirs 6x60 mm + 2x120 mm
- 4 roues 130 mm : 2 pivotantes 2 avec freins
- couleurs : rouge, noir, bleu, orange
- 1 support façons

Afm/dim	L 80 cm	B 50 cm	H 103 cm
gewicht/poids	75 kg		totale hoogte

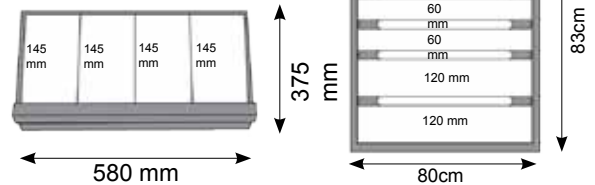

## FOR 10218R

## FOR 10218C

## FOR 10218B



### Gereedschapswagen 8 laden

- Afm/dimeting laden : 580 mm x 375 mm
- 7 laden - 60 mm hoog
- 1 lade - 120 mm hoog
- wielen 130 mm : 2 vaste en 2 zwenkwielen waarvan 2 met rem
- kleuren : rood, zwart, blauw
- geleverd met 1 spuitbushouder
- abs bovenblad

### Servante 8 tiroirs

- dimensions tiroirs : 580 mm x 375 mm
- tiroirs 7x60 mm + 1x120 mm
- roues 130 mm : 2 pivotantes 2 avec freins
- couleurs : rouge, noir, blue
- 1 support façons

Afm/dim	L 80 cm	B 50 cm	H 103 cm
gewicht/poids	75 kg		totale hoogte

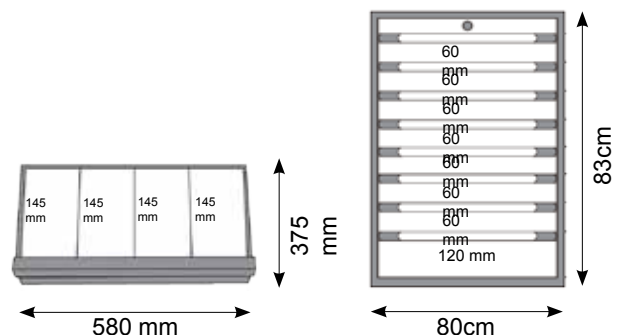

## FOR 102104R/102104

Zijtafel voor gereedschapswagen 10217-10218-10318  
*Table pour reception d'ordinateur portable*



## FOR 102105R/102105

Papierrolhouder 10217-10218-10318  
*Porte papier*  
*Porte papier*



## FOR 102102R/102102

Flessenhouder aan de zijkant de bevestigen  
*Porte flacons latéral*



## FOR 102101R/102101

Zijkast afsluitbaar met slot & 2 sleutels  
*Coffre latéral avec serrure*



## FOR 102106R/102106

Zijbakje voor spuitbussen  
*Support flacons (L430 x B90 x H120 mm)*



## FOR 102106B/102106A

Zijbakje voor spuitbussen  
*Support flacons (L430 x B90 x H120 mm)*



## FOR 102103

ABS bovenblad 10217-10218  
- 2 ingebouwde handgrepen  
*Plan de travail ABS*



**FOR 102170CB**

Wiel zwenkbaar met rem dia 125 mm  
*Roue avec frein pivotante*



**FOR 102170C**

Wiel zonder rem dia 125 mm  
*Roue sans frein*



**FOR 102170BBS E**

Ladegleiders zie pag.  
*Jeu de glissières à billes (voir pag)*

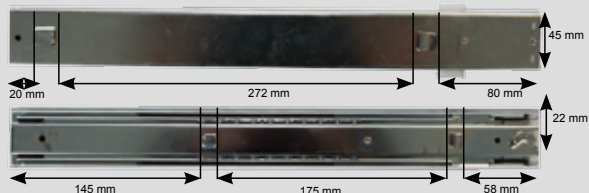

**FOR 102170LK**

Slot 2 sleutels (10225-10217-10218-10318)  
*Serrure + 2 clés (10225-10217-10218-10318)*



**FOR 102170DS**

Lade small (L58cmxB38cmxH6cm)  
*Tiroir small*



**FOR 102170DL**

Lade Large (L58cmxB38xH12cm)  
*Tiroir large*



## FOR 10318C

## FOR 10318R

## FOR 10318B

### Jumbo Gereedschapswagen 8 laden

Afm/dim. laden : 750 mm x 435 mm

- 7 laden H 6cm 1 lade H 12cm
- wielen 130 mm : 2 vaste en 2 zwenkwielen waarvan 2 met rem
- kleur : zwart/rood
- bovenblad
- geleverd met 2 spuitbushouders regelbaar + zijhandvat
- 4 stootranden

### Servante Jumbo 8 tiroirs

- tiroirs : 750 mm x 435 mm
- 7 tiroirs H 6cm 1 tiroir H12 cm
- roues 130 mm : 2 pivotantes 2 avec freins
- couleur : noir-rouge
- 2 supports flacons + poignée

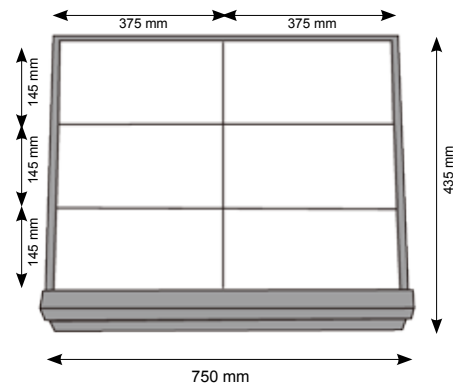

Afm/dim	L 95 cm	B 50 cm	H 100 cm
gewicht/poids	107 kg		totale hoogte

# Jumbo



**FOR 103106**

Zijbakje voor spuitbussen 10318 jumbo zwart  
(L470 x B90 x H120 mm)  
*Support flacons 10318 Jumbo noir*



**FOR 103106R**

Zijbakje voor spuitbussen 10318 jumbo rood  
*Support flacons 10318 Jumbo rouge*



**FOR 103180CB**

Wiel zwenkbaar met rem  
*Roue avec frein pivotante*



**FOR 103180C**

Wiel zonder rem  
*Roue sans frein*



**FOR 10318BBS**

Ladegeleiders per paar zie pag. 286  
*Jeu de glissières à billes (voir pag 286)*



**FOR 102170LK**

Slot 2 sleutels (10225-10217-10218-10318)  
*Serrure + 2 clés (10225-10217-10218-10318)*



**FOR 103180DS**

Lade small (L75cmxB44cmxH6cm)  
*Tiroir small*



**FOR 103180DL**

Lade Large (L75cmxB44cmxH12 mm)  
*Tiroirs large*



**FOR 10210H1**

Doppenhouder in metaal  
*Support pour douilles en metal*



**FOR 10210H2**

Houder voor schroevendraaiers  
*Support pour tournevis*



**FOR 10210H3**

Houder voor sleutels  
*Support pour clés*



**FOR 10210H4**

Houder voor T sleutels  
*Support pour clés en T*



**FOR 82023S**

Enkele haak 75 mm L  
*Crochet simple 75 mm L*



**FOR 82023D**

Dubbele haak 75 mm L  
*Crochet double 75 mm L*



**FOR 82026S**

Enkele haak 150 mm L  
*Crochet simple 150 mm L*



**FOR 82026U**

Dubbele haak 150 mm L  
*Crochet double 150 mm L*





## FOR 50212

### Service wagen 2 laden

- Afm/dimeting lades : 580 mm x 375 mm
- indeling van de lades hoogte 2x60 mm
- werkblad : 49 cm x 76 cm
- 4 wielen 100 mm : 2 vaste en 2 zwenkwielen waarvan 2 met rem
- handvat
- spuitbushouder
- afvalbakje
- gewicht 22.5kg

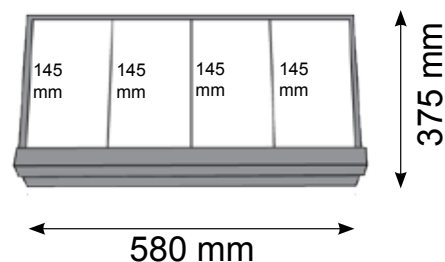

### Service station 2 tiroirs

- dimensions tiroirs : 580 mm x 375 mm
- dimensions tiroirs hauteur 2x60 mm
- plateau : 49 cm x 76 cm
- 4 roues 100 mm : 2 pivotantes
- poignée
- support flacons
- bac à déchets
- poids 22.5kg





## FOR 50253

### Werkbank met gereedschapswand en koffer

- Ladenkoffer 3 laden (FOR 50223)
- indeling van de laden : op kogellagers
- veiligheidsslot met 2 sleutels
- bodem van de laden met rubbermatten
- geleverd met 10 dubbele haken
- 10 enkele haken

### Etabli avec coffre et panneau

- coffre 3 tiroirs
- verrouillage de sécurité centralisé avec 2 clés
- livré avec 20 crochets
- capacité 1000kg

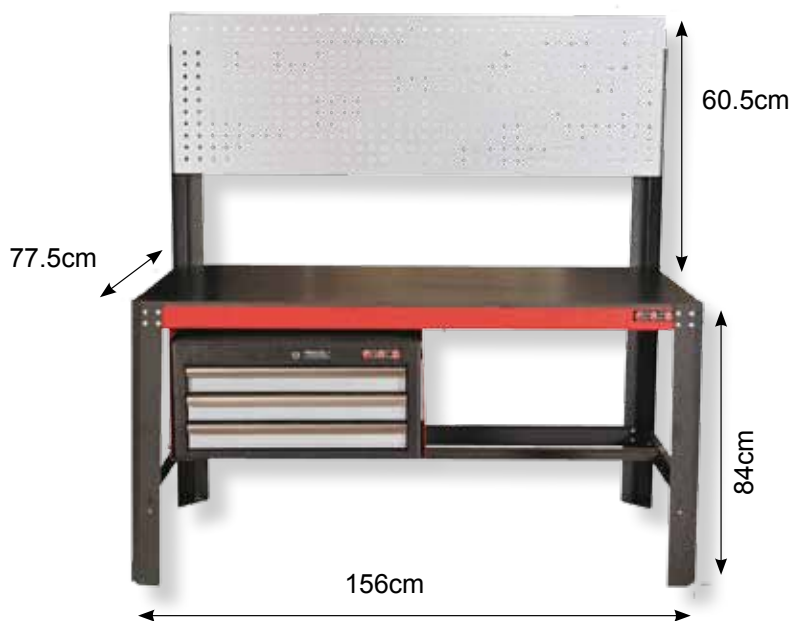

## FOR 50254

### Werkbank met gereedschapswand en koffer

- gereedschapswand met mogelijkheid voor muurbevestiging, roldeur met veiligheidsslot
- Ladenkoffer 3 laden (50223)
- indeling van de laden : op kogellagers
- veiligheidsslot met 2 sleutels
- bodem van de laden met rubbermatten
- geleverd met 10 dubbele haken
- 10 enkele haken
- werkblad van multiplex hout met plastic laminaat
- laadcapaciteit 1000kg

### Etabli complètement en métal avec coffre et porte-outils

- paroi porte outils
- coffre 3 tiroirs (50223)
- verrouillage de sécurité centralisé avec 2 clés
- livré avec 20 crochets
- capacité 1000kg



## FOR 5001

### Werkbank

- geleverd zonder koffer

### Etabli

- sans coffre

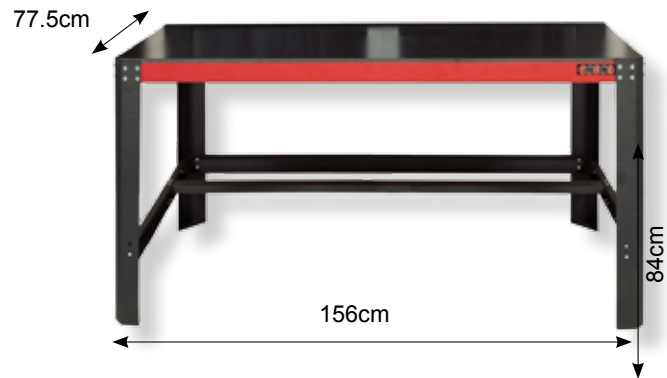

## FOR 5003

### Gereedschapswand

- gereedschapswand met mogelijkheid voor muurbevestiging, roldeur met veiligheidsslot met 2 sleutels
- geleverd met 10 dubbele haken
- 10 enkele haken
- 156cmL x 60.5cmB x 20cmD

### Armoire

- paroi porte outils
- verrouillage de sécurité centralisé avec 2 clés
- livré avec 20 crochets

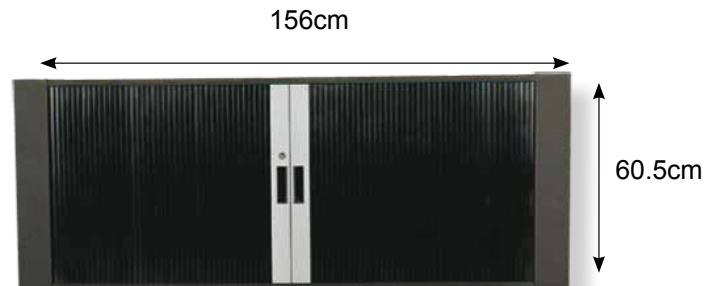

## Ladenkasten - Armoires de rangements

### B723xD653xH1000mm

- centrale vergrendeling-fermeture centrale
- 100 kg per lade belastbaar/100 kg par tiroir
- 100% uitschuifbaar, tiroirs s'ouvert 100%
- kleur-couleur : grijs-gris(RAL7035)
- alu handgrepen - manches alu

## TC XC90 5SG

### Ladenkast 5 laden

- 3 laden 200 mm H
- 2 laden 150 mmH
- gewicht: 100kg

### Armoire 5 tiroirs

- 3 tiroirs 200 mm H
- 2 tiroirs 150 mmH
- poids : 100kg

## TC XC90 6SG

### Ladenkast 6 laden

- 3 laden, tiroirs 100 mm H
- 2 laden, tiroirs 150 mm H
- 1 lade, tiroir 200 mm H
- gewicht/poids : 108kg

### Armoire 6 tiroirs

- 3 tiroirs 100 mm H
- 2 tiroirs 150 mm H
- 1 tiroir 200 mm H
- poids : 108kg

## TC XC90 8SG

### Ladenkast 8 laden

- 2 laden 75 mm H
- 4 laden 100 mm H
- 1 lade 150 mm H
- 1 lade 200 mm H
- gewicht: 118.10 kg

### Armoire 8 tiroirs

- 2 tiroirs 75 mm H
- 4 tiroirs 100 mm H
- 1 tiroir 150 mm H
- 1 tiroir 200 mm H
- poids : 118.10 kg

## TC XC90 10SG

### Ladenkast 10 laden

- 4 laden 75 mm
- 6 laden 100 mm
- gewicht 128.20kg

### Armoire 10 tiroirs

- 4 tiroirs 75 mm
- 6 tiroirs 100 mm
- poids : 128.20kg

## TC XCDKC

### Bovenblad frame

### Plan de travail

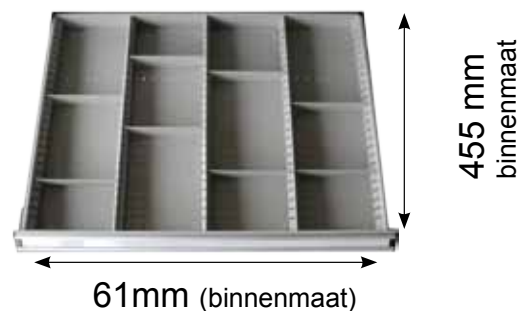

## PVC indelingen voor ladenkasten

### Boîte à outils

Art. nr.	Afm/dim. mm	
<b>TC XC SH11</b>	150 x 150 x 28	roulementen
<b>TC XC SH12</b>	150 x 150 x 28	roulementen
<b>TC XC SH13</b>	150 x 150 x 28	met tusenschotjes
<b>TC XC SH21</b>	750 x 750 x 46	bakje, bacs
<b>TC XC SH22</b>	150 x 75 x 46	bakje, bacs
<b>TC XC SH23</b>	150 x 150 x 46	bakje, bacs



## Universele lade indeling van alle kasten

### Présentation des tiroirs

#### Lade 1

- SH11 6 stuks
- SH12 3 stuks
- SH13 3 stuks

#### Tiroir 1

- SH11 6 pièces
- SH12 3 pièces
- SH13 3 pièces



#### Lade 2

- SH21 16 stuks
- SH22 8 stuks
- SH23 4 stuks

#### Tiroir 2

- SH21 16 pièces
- SH22 8 pièces
- SH23 4 pièces



## Andere lades

- metalen indelingen

### Autres tiroirs

- en métal

Art. nr.	Afm/dim. mm	per lade	voor lade
<b>TC XC75</b>	450Lx46H	3st	75 mmH
<b>TC XC75PL</b>	154Lx43H	8st	75 mmH
<b>TC XC100</b>	450Lx71hH	3st	100 mmH
<b>TC XC100PL</b>	154Lx65H	8st	100 mmH
<b>TC XC 150</b>	450Lx121H	3st	150 mmH
<b>TC XC 150PL</b>	154Lx115H	8st	150 mmH
<b>TC XC 200</b>	450Lx171H	3st	200 mmH
<b>TC XC200PL</b>	154Lx165H	8st	200 mmH

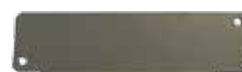



# Gevulde gereedschapswagen - servante

## FOR 10217C219

### FOR 10217R219

#### Gevulde gereedschapswagen 7 laden gevuld met gereedschap 219 delig

- 3 laden gevuld 12 modules

gewicht : 87.3kg

#### Servante d'atelier 7 tiroirs avec outils 219 pcs

- 12 modules pour 3 tiroirs

poids : 87.3 kg



## FOR VUL 219

#### Assortiment gereedschap 219 delig

- 3 laden 12 modules

#### Assortiment d'outils 219 pcs

- 12 modules pour 3 tiroirs

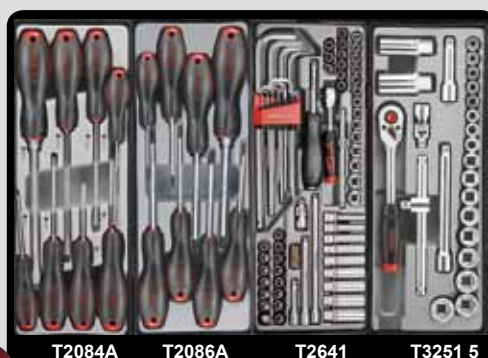

1



2



3

## FOR 10217C245 FOR 10217R245

### Gevulde gereedschapswagen 7 laden gevuld met gereedschap 245 delig

- 4 laden gevuld 15 modules
- gewicht :100kg

### Servante d'atelier 7 tiroirs avec 245 pcs d'outils

- 15 modules pour 4 tiroirs
- poids - 100kg



## FOR VUL 245

### Assortiment gereedschap 245 delig

- 4 laden - 15 modules

### Assortiment d'outils 245 pcs

- 15 modules pour 4 tiroirs

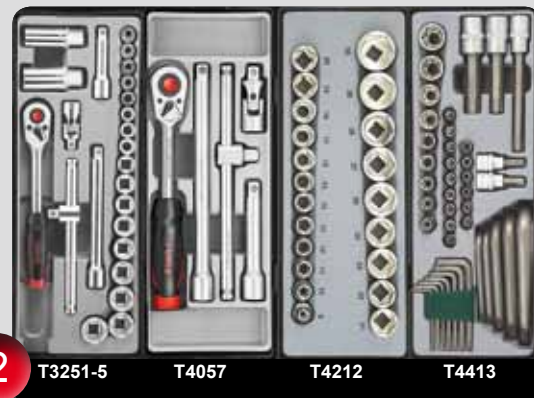

# Gevulde gereedschapswagen-servante

**FOR 10217C286**

**FOR 10217R286**

**FOR 10217A286**

**FOR 10217B286**

**Gereedschapswagen 7 laden gevuld met gereedschap 286 delig**

- 6 laden gevuld 22 modules
- gewicht :105kg

**Servante mobile d'atelier 7 tiroirs avec 286 pcs d'outils**

- 22 modules pour 6 tiroirs poids : 105 kg

**FOR VUL 286**

**Assortiment gereedschap 286 delig**

- 6 laden - 22 modules

**Assortiment d'outils 286 pcs**

- 22 modules pour 6 tiroirs

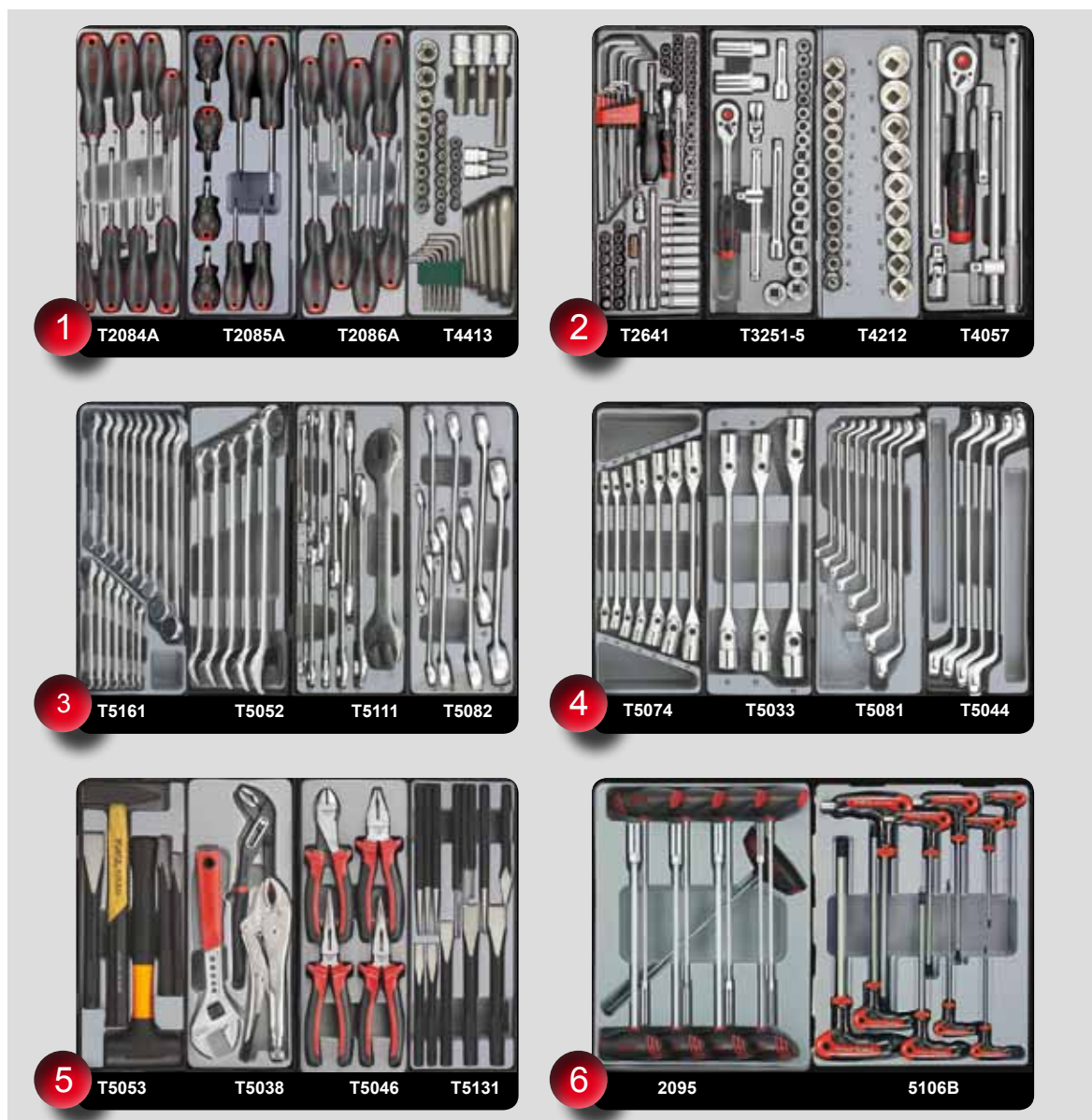



**FOR 10217C306**

**FOR 10217R306**

**FOR 10217A306**

**FOR 10217B306**

**Gereedschapswagen 7 laden gevuld met gereedschap 306 delig**

- 6 laden gevuld 22 modules
- gewicht : 106.7 kg

**Servante mobile d'atelier 7 tiroirs avec 306 pcs d'outils**

- 22 modules pour 6 tiroirs
- poids 106.7 kg

**FOR VUL 306**

**Assortiment gereedschap 306 delig**

- 6 laden - 22 modules

**Assortiment d'outils 306 pcs**

- 22 modules pour 6 tiroirs

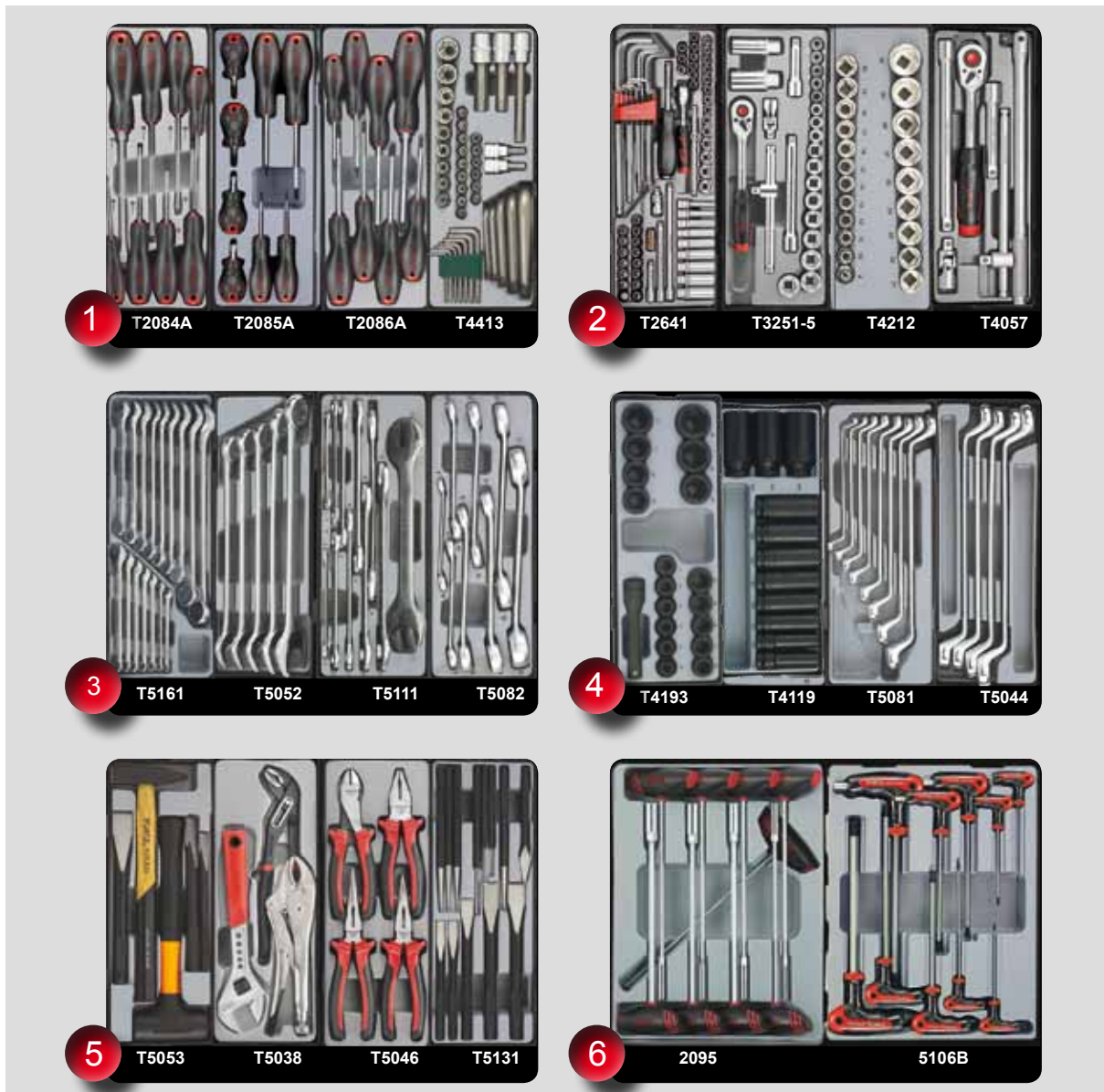



## FOR 10217C361

### FOR 10217R361

#### Gereedschapswagen 7 laden gevuld met gereedschap 361 delig

- 6 laden gevuld 24 modules
- gewicht : 107.3 kg

#### Servante mobile d'atelier 7 tiroirs avec 361 pcs d'outils

- 24 modules pour 6 tiroirs
- poids : 107.3 kg



## FOR VUL 361

#### Assortiment gereedschap 361 delig

- 6 laden gevuld - 20 modules

#### Assortiment d'outils 361 pcs

- 20 modules pour 6 tiroirs



## FOR 10218C376

### FOR 10218R376

### FOR 10218B376

#### Gevulde gereedschapswagen 8 laden gevuld met gereedschap 376 delig

- 6 laden gevuld 22 modules
- gewicht : 112.7 kg

#### Servante mobile d'atelier 8 tiroirs avec 376 pcs d'outils

- 22 modules pour 6 tiroirs
- gewicht 112.7 kg



## FOR VUL 376

#### Assortiment gereedschap 376 delig

- 6 laden - 22 modules

#### Assortiment d'outils 376 pcs

- 22 modules pour 6 tiroirs



## FOR 10318C437

## FOR 10318R437

**Gevulde gereedschapswagen 8 laden gevuld met gereedschap 437 delig**

- 6 laden gevuld 32 modules
- gewicht :192 kg

**Servante mobile d'atelier 8 tiroirs avec 437 pcs d'outils**

- 32 modules pour 6 tiroirs
- poids : 192kg

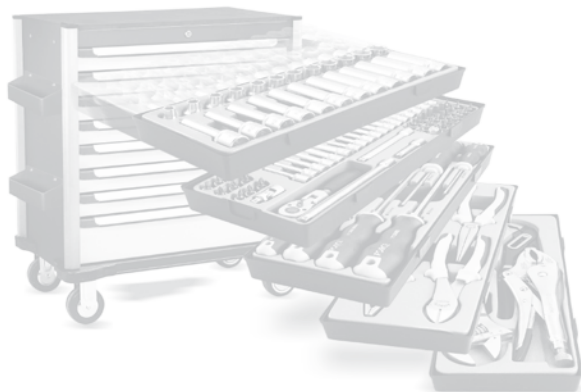

# Jumbo

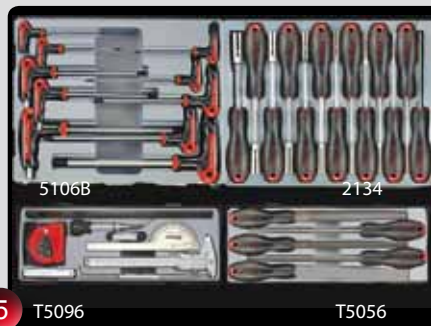

## FOR VUL 437

**Assortiment gereedschap 437 delig**

- 6 laden 32 modules

**Assortiment d'outils 437 pcs**

- 32 modules pour 6 tiroirs



# Gevulde gereedschapswagen Jumbo

## FOR 10318C431

Gereedschapswagen 6 laden gevuld met gereedschap  
431 delig mm & engelse maten

- 6 laden gevuld 32 modules
- gewicht : 200kg

*Servante mobile d'atelier 8 tiroirs avec 431 pcs d'outils  
metric + en pouce*

- 6 tiroirs avec 22 modules
- poids : 200kg



# Jumbo

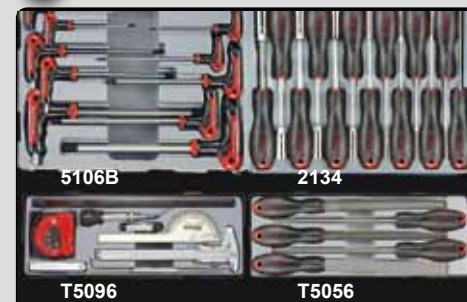

## FOR 1013-562

### FOR 1013R562

Gevulde gereedschapswagen 8 laden  
 gevuld + koffer 5 laden met gereedschap 562 delig

*Servante mobile d'atelier 8 tiroirs avec coffre 5 tiroirs avec  
 562 pcs d'outils*

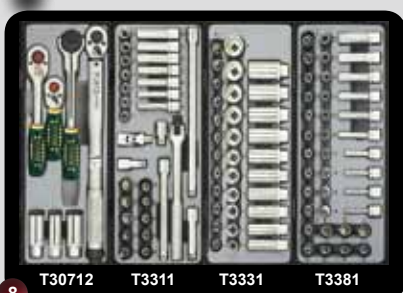
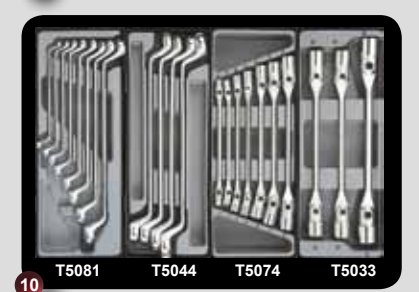
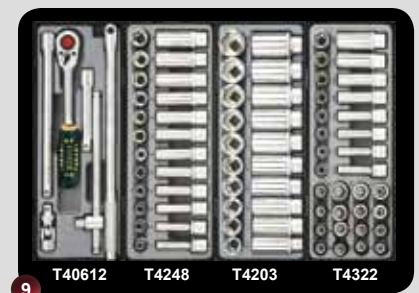



## FOR 10217C198

### Gevulde gereedschapswagen 7 laden gevuld met gereedschap 198 delig

- 5 laden gevuld foams
- gewicht : 111kg

### Servante mobile d'atelier 7 tiroirs avec 198 pcs d'outils

- 5 tiroirs avec foam
- poids : 111kg



1 FOR F2412 Module schroevendraaiers + L sleutels 41 delig



2 FOR F4882 Module 1/4"-3/8"-1/2" assortiment doppen 88 delig - Module de douilles 88 pcs

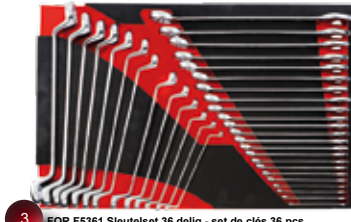

3 FOR F5361 Sleutelset 36 delig - set de clés 36 pcs

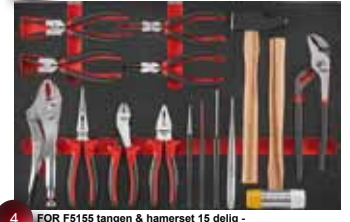

4 FOR F5155 tangen & hamerset 15 delig - set de pinces & marteau 15 pcs



5 OR F5186 Combinatieset 18 delig - assortiments 18 pcs

## FOR 10217C259

### Gevulde gereedschapswagen 7 laden gevuld met gereedschap 259 delig

- 5 laden gevuld 5 foams
- gewicht 74.5kg

### Servante mobile d'atelier 7 tiroirs avec 259 pcs d'outils

- 5 modules foam pour 5 tiroirs
- poids : 75.4 kg

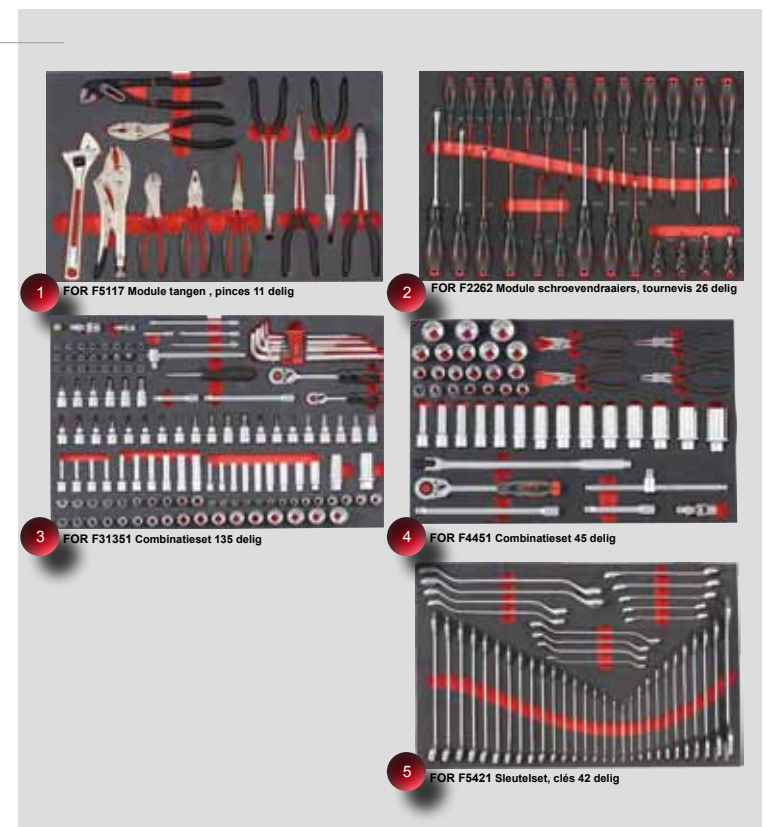

1 FOR F5117 Module tangen , pinces 11 delig



2 FOR F2262 Module schroevendraaiers, tournevis 26 delig



3 FOR F31351 Combinatieset 135 delig



4 FOR F4451 Combinatieset 45 delig

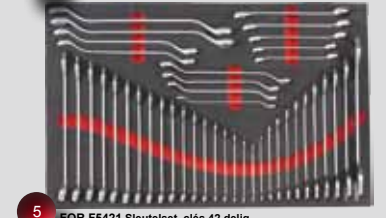

5 FOR F5421 Sleutelset, clés 42 delig

## FOR 10217C308

**Gevulde gereedschapswagen 7 laden gevuld met gereedschap 308 delig**

- 6 laden gevuld
- gewicht : 111kg

**Servante mobile d'atelier 7 tiroirs avec 308 pcs d'outils**

- 6 tiroirs avec 6 modules foam
- poids : 111kg



1 FOR F2412 Module schroevendraaiers + L sleutels 41 delig



2 FOR F4882 Module 1/4 -3/8 -1/2 assortiment doppen - 88 delig - Module de douilles 88 pcs

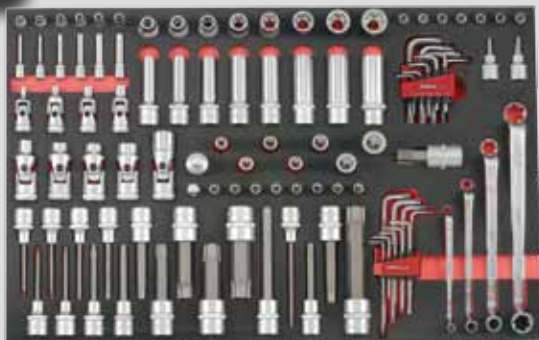

3 FOR F41041 Combinatieset 104 delig - set de combination



4 FOR F5361 sleutelset 36 delig - set de clés 36 pcs



5 FOR F5207 Tangen & beitset 20 delig assortiments 20 pcs

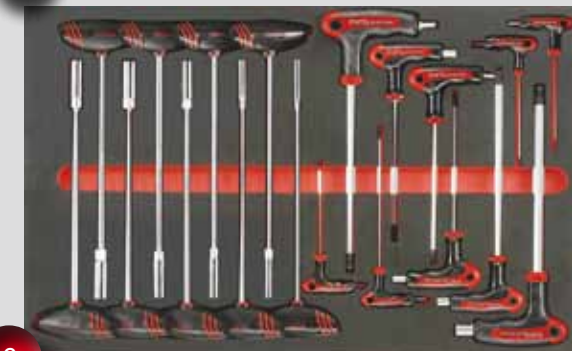

6 FOR F2195 T hendel set 19 delig - assortiments 19 pcs



# Gevulde gereedschapswagen foam JUMBO - foam-servante d'atelier

## FOR 10318C298

Gevulde jumbo gereedschapswagen 8 laden  
gevuld met gereedschap 298 delig

- 5 laden gevuld

*Servante mobile d'atelier 8 tiroirs avec 298 pcs d'outils*

- 5 modules foam pour 8 tiroirs

# Jumbo

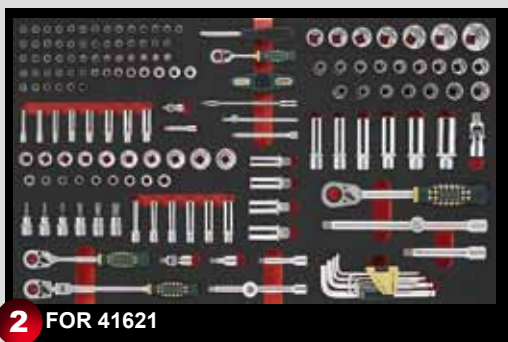
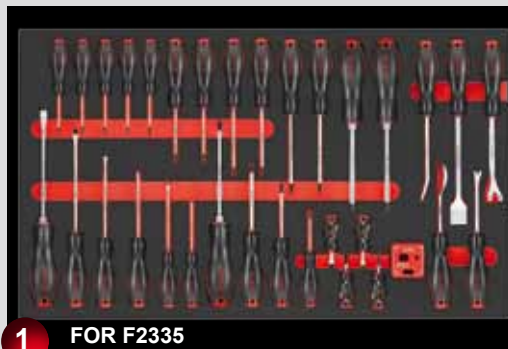

## FOR 10318C610

Gevulde jumbo gereedschapswagen 8 laden  
gevuld met gereedschap 610 delig  
- 8 laden gevuld

*Servante mobile d'atelier 8 tiroirs avec 610 pcs d'outils*  
- 8 modules foam pour 8 tiroirs

# Jumbo

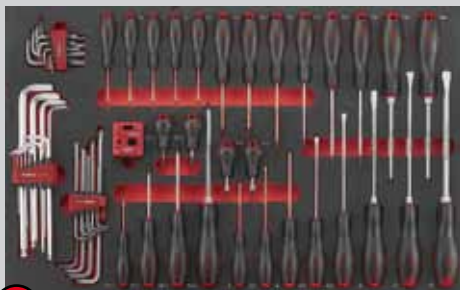

**1** FOR F2592 schroevendraaiers + L sleutels 59dlg



**2** FOR F31921 1/4"-3/8" combinatie set 192dlg

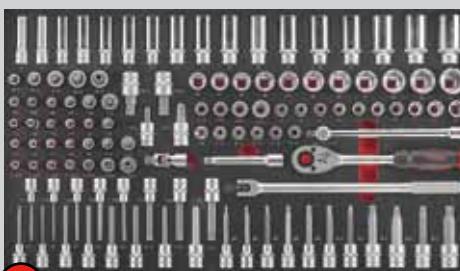

**3** FOR F41162 1/2" doppelset 116dlg



**4** FOR F5505 sleutelset 50dlg 6-32mm



**5** FOR F5461 sleutelset 46dlg



**6** FOR F5296 tangen-beitset 29dlg



**7** FOR F5292 sleutelset 29dlg



**8** FOR F4491 slagdoppelset 89dlg



# Gevulde gereedschapswagen JUMBO - foam-servante d'atelier

**FOR 10318C509**

**FOR 10318R509**

Gevulde jumbo gereedschapswagen 8 laden  
gevuld met gereedschap 509 delig

- 8 laden gevuld

*Servante mobile d'atelier 8 tiroirs avec 509 pcs d'outils*

- 8 modules foam pour 8 tiroirs

# Jumbo



**1** FOR F2452



**5** FOR F5173



**2** FOR F21251



**6** FOR F5242



**3** FOR F41491



**7** FOR F5521

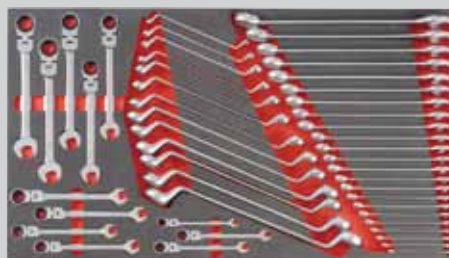

**4** FOR F5481



**8** FOR F4491

**FOR 10318C607**

**Jumbo Truck**

Gevulde jumbo gereedschapswagen 8 laden  
gevuld met gereedschap 607 delig voor trucks  
- 8 laden gevuld

*Servante mobile d'atelier 8 tiroirs avec 607 pcs d'outils*  
- 8 modules foam pour 8 tiroirs



**1** FOR F32031 1/4"-3/8" combinatieset 203dlg



**5** FOR F5522 sleutelset 63dlg

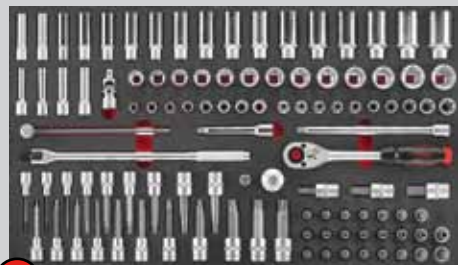

**2** FOR F41062 doppenet 1/2" 106dlg

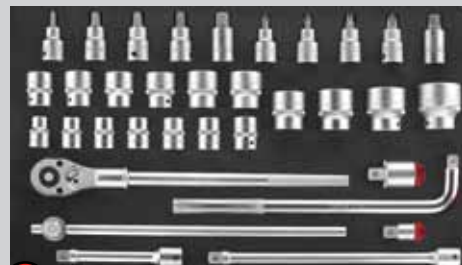

**6** FOR F6342 doppenet 3/4" 34 dmg 17-50mm



**3** FOR F41001 slagdoppenet 1/2" 100 dlg



**7** FOR F6431 slagdoppenet 3/4" 43dlg 17-46mm

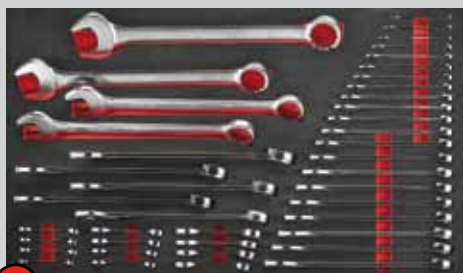

**4** FOR F5422 sleutelset 42 dlg 6-38mm



**8** FOR F5272 combinatieset 27dlg

## TC module systeem

*maak je eigen selectie en stel zelf je gereedschapswagen samen*  
*composer votre servante*

- 4 modules per lade (50223-10225-10217-10218)
  - 6 modules per lade (enkel Jumbo model 10318)
  - alle modules ook leeg verkrijgbaar
- afm. TC module 37cm x 14cm

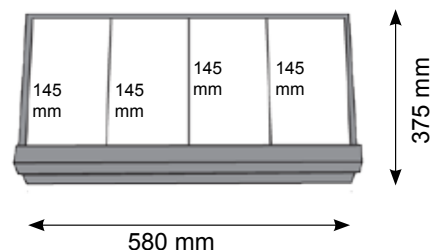

TC module 37cm x 14 cm 4 per lade 10217- 6 per lade 10318	10218
--	-------

Large module 37cm x 28 cm 2 per lade	
--	--

### FOR T2084A

Schroevendraaierset 8 delig  
 Module 8 tournevis



### FOR T2085A

Schroevendraaierset pozidriv 8 delig  
 Module 8 tournevis pozidriv

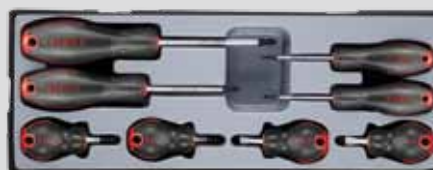

### FOR T2086A

Torx schroevendraaierset 8 delig  
 Module 8 tournevis torx



### FOR T20712

Schroevendraaierset geïsoleerd 8 delig  
 Module 8 tournevis 1000v



### FOR T2173

Mini schroevendraaierset 17 delig  
 Module 17 tournevis mini



### FOR T20612

Module 6dlg schroevendraaier op dop  
 Module 6 tournevis sur douilles



### FOR T50637

Module 6 inbussleutel met handvat  
 Module 6 clés mâles avec poignée L 2-3-4-5-6-8mm





**FOR T2045**

1/4" Ratelset 4 delig  
Module cliquet 1/4" 4 pcs



**FOR T2641**

1/4" Doppenassortiment 65 delig  
Module douilles et acc. 65 pcs 1/4"



**FOR T2742**

1/4" Doppenassortiment 74 delig  
Module assortiment douilles 1/4" 74 pcs



**FOR T2741**

1/4" Doppenassortiment mm + Inch 74 delig  
Module douilles et acc. 74 pcs 1/4" mm + Inch





**FOR T30711**

3/8" Ratelset 7 delig  
Module cliquet 3/8" 7 pcs



**FOR T30712**

3/8" Ratelset 7 delig  
Module cliquet 3/8" 7 pcs



**FOR T3251 5**

3/8" Doppensortiment 24 delig  
Module douilles et acc. 24 pcs 3/8"



**FOR T3212**

3/8" Doppensortiment 21 delig inch  
Module douilles et acc. en pouce 21 pcs 3/8"



**FOR T3193**

3/8" Doppenset kort + lang inch 19 delig  
Module 19 douilles en pouce 3/8"



**FOR T3121**

3/8" Lange doppenset 12 delig 6k  
Module 12 douilles longues 6p



**FOR T3331**

3/8" Doppenset 33 delig kort + lang  
Module 33 douilles 3/8"



**FOR T3322**

3/8" Doppensortiment 32 delig mm & inch  
Module de douilles 32 pcs mm + inch



**FOR T3311**

3/8" Kombinatieset 31 delig  
Module douilles et acc. 31 pcs 3/8"



**FOR T3381**

3/8" Torx & XZN set 38 delig  
Module 38 douilles torx & XZN 3/8"



**FOR T3521**

Torxset 52 delig  
Module jeu de torx 52 pcs

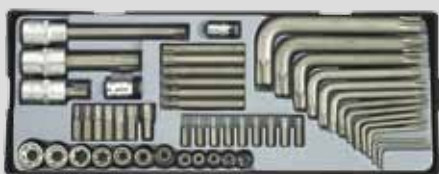

**FOR T3361**

Doppenassortiment 36 delig  
Module douilles et acc 36 pcs



**FOR T31010**

3/8" Bougiedoppenset 10 dlg  
Module douilles pour bougies 3/8" 10pcs



**Slagdoppen - douilles à choc**

**FOR T8151**

Slagmoer adapter set 15 delig  
Module 15 adaptateur à choc



**FOR T4205**

1/2" Slagdoppenset torx-inbus 20 delig  
Module 20 douilles à chocs torx-hex



**FOR T4193**

1/2" Slagdoppenset 19 delig  
Module 19 douilles à choc 1/2"



**FOR T4119**

1/2" Lange slagdoppenset 11 delig  
Module 11 douilles à choc longues 1/2"



**FOR T6121**

3/4" Slagdoppenset 12 delig  
Module 12 douilles à choc 3/4"



**FOR T6085**

3/4" Lange slagdoppenset 8 delig  
Module 8 douilles à choc longues 3/4"



**FOR T4057**

1/2" Ratelset & accessoires 5 delig  
Module de 4 accessoires + cliquet 1/2"



**FOR T40612**

1/2" Ratelset & accessoires 6 delig  
Module de 5 accessoires + cliquet 1/2"



**FOR T4212**

1/2" Doppenset metric 6k 21 delig  
Module 21 douilles 6 pans 1/2"



**FOR T4212-9**

1/2" Doppenset 12k 21 delig  
Module 21 douilles 12 pans 1/2"



**FOR T4194**

1/2" Doppenset 19 delig inch 6k  
Module 19 douilles 6 pans en pouce 1/2"



**FOR T4203**

1/2" Doppenset kort + lang 6kant 20 delig  
Module 20 douilles 6 pans 1/2"



**FOR T4143**

1/2" Lange doppenset 6k 14 delig  
Module 14 douilles longues 6 pans 1/2"



**FOR T4143 9**

1/2" Lange doppenset 12k 14 delig  
Module 14 douilles longues 12 pans 1/2"



**FOR T4248S**

1/2" Doppenset kort + lang inch 6k 24 delig  
Module 24 douilles 6 pans en pouce 1/2"



**FOR T4248**

1/2" Doppenset kort + lang 6k 24 delig  
Module 24 douilles 6 pans 1/2"



**FOR T4226**

1/2" Doppenset 6k 22 delig  
Module douilles 6 pans 22 pcs 1/2"



**FOR T4413**

Torxset 41 delig  
Module de douilles torx 41 pcs



**FOR T4122**

1/2" Mixed doppenset 12 delig  
Module 12 douilles tournevis 1/2"



**FOR T4116**

1/2" Mixed doppenset 11 delig  
Module 11 douilles 1/2"

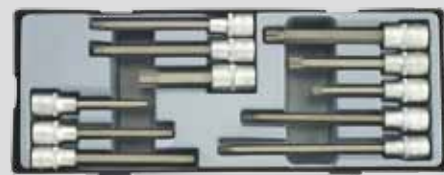

**FOR T4322**

1/2" Torx & XZN dopbitset 32 delig  
Module 32 douilles torx & XZN 1/2"



**FOR T4281**

1/2" Doppenassortiment 27 delig  
Module 27 douilles 1/2"

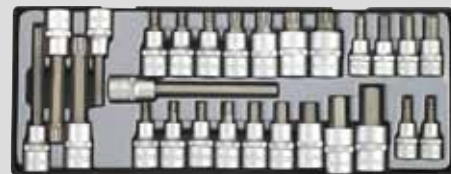

**FOR T4583**

Module 58dlg dop -bit-torx set  
Module 58 embouts - douilles torx hex





## FOR T5046

Tangenset 4 delig  
Module 4 pincers



## FOR T5043A

Borgveertangenset 4 delig  
Module 4 pincers circlips



## FOR T50410

Geisoleerde tangenset 4 delig  
Module 4 pincers isolées 1000v

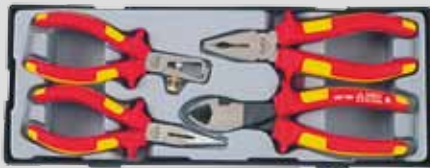

## FOR T5038

Tangenset 3 delig  
Module 3 pincers



## FOR T5023

Verstelbare moersleutelset 2 delig  
Module 2 clés à molette



## FOR T5036

Verstelbare moersleutelset 2 delig  
Module 2 clés à molette



## FOR T5047

Lange tangenset 4 delig  
Module 4 pincers longues



## FOR T50814

Minitangenset 8 delig  
Module 8 pincers mini



## FOR T5057

Multi grip tangenset 5 delig  
Module 5 pincers étau axiale



**FOR T5161**

Steekringsleutelset 16 delig  
Module 16 clés mixtes



**FOR T5134**

Steekringsleutelset inch 13 delig  
Module 13 clés mixtes en pouce



**FOR T5181**

Steekringsleutelset 18 delig  
Module 18 clés mixtes



**FOR T5089**

Steekringsleutelset 8 delig  
Module 8 clés mixtes



**FOR T5052**

Steekringsleutelset 5 delig  
Module 5 clés mixtes



**FOR T51214**

Mini steekringsleutelset 12 delig  
Module 12 clés mixtes mini



**FOR T5111S**

Steeksleutelset 11 delig inch  
Module 11 clés à fourches en pouce



**FOR T5111**

Steeksleutelset 11 delig  
Module 11 clés à fourches



## FOR T5081

Gebogen ringsleutelset 8 delig 75°  
Module 8 clés polygonales 75°



## FOR T5044

Gebogen ringsleutelset 4 delig 75°  
Module 4 clés polygonales



## FOR T5079S

Gebogen ringsleutelset inch 7 delig 75°  
Module 7 clés polygonales 75° en pouce



## FOR T5085

Gebogen ringsleutelset 8 delig 45°  
Module 8 clés polygonales 45°



## FOR T51226

Platte ringsleutelset 12 delig 6-32 mm  
Module 12 clés à polygonales plates 6-32 mm



## FOR T5085S

Gebogen ringsleutelset inch 8 delig 45°  
Module 8 clés polygonales 45° en pouce



## FOR T50817

Pijpsleutelset 8 delig 6k  
Module 8 clés à pipe



## FOR T5114

Gebogen pijpsleutelset 11 delig  
Module 11 clés à pipe pliés



## FOR T5082

Open ringsleutelset 8 delig  
Module 8 clés tuyauter



## FOR T50710S

Open ringsleutelset inch 7 delig  
Module 7 clés tuyauter en pouce



**FOR T5074**

Kniesleutelset 7 delig  
Module 7 clés à douilles articulées



**FOR T5033**

Kniesleutelset 3 delig  
Module 3 clés à douilles articulées



**FOR T50616S**

Kniesleutelset 6 delig inch  
Module 6 clés à douilles articulées inch



**FOR T5172**

Opsteek steeksleutelset 17 delig  
Module 17 clés pied à corneille



**FOR T51211**

Ratel-steekringsleutel omkeerbaar 12 delig  
Module 12 clés mixtes à cliquet resersible 8-19 mm



**FOR T51210**

Ratel-steekringsleutel 12 delig  
Module 12 clés mixtes à cliquet



**FOR T5164R**

Omkeerbare ratelsleutelset met adapters 16 delig  
Module 16 clés mixtes à cliquet réversible



**FOR T50617**

Ring ratelsleutel torx 6 delig  
Module 6 clés à cliquet torx



**FOR T50810**

Ring-ratelsleutelset 8 delig 8-22 mm  
Module 8 clés polygonales à cliquet 8-22 mm



**FOR T50811**

Gebogen ringratelsleutelset 8 delig 8-22 mm  
Module 8 clés polygonales courbé à cliquet 8-22 mm





**FOR T51811**

Riveteertangset 181 delig  
Module rivetage 181 pcs



**FOR T5056**

Vijlenset 5 delig  
Module 5 limes



**FOR T5122**

Olie pluggenset 12 delig  
Module 12 outils de graissage



**FOR T905M2**

Demontage gereedschapset 5 delig  
Module 5 grattoirs & crochets



**FOR T5331**

Repair tools set 33 delig  
Module 33 outils reparation



**FOR T5053**

Hamer - beitelset 5 delig  
Module 5 acc.marteau et burins



**FOR T5131**

Beitel - en penuitdrijverset 13 delig  
Module 13 poinçons et burins



**FOR T5096**

Meetgereedschapset 9 delig  
Module d'outillage de mesure 9 pcs



**FOR T5055**

Snijgereedschapset 5 delig  
Module 5 outils à couper



**FOR PT5000**

Module leeg B38cm x L14 cm x H4.5cm  
Module vide 38x14 cm



# Large

Modulair syteem | 2 per lade (28x37cm x H4cm)

## FOR 2142A

Schroevendraaierset 14 delig  
*Module 14 tournevis*



## FOR 2137A

Torx schroevendraaierset 13 delig  
*Module 14 tournevis torx*



## FOR 2108

Hamer schroevendraaierset 10 delig philips  
*Module 10 tournevis à fraper, philips*



## FOR 2109

Hamer schroevendraaierset 10 delig pozidriv  
*Module 10 tournevis à fraper pozidriv*

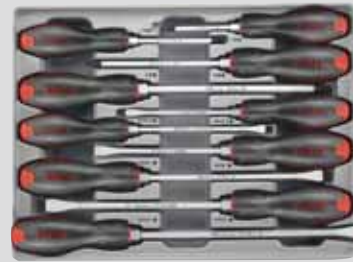

## FOR 2125

Schroevendraaierset 1000v PH 12 delig  
*Module 12 tournevis 1000v*



## FOR 2126

Schroevendraaierset 1000v pozidriv 12 delig  
*Module 12 tournevis 1000v pozidriv*



## FOR 2095

Dop op T handvat 9 delig  
Module 9 douilles poignées en T



## FOR 2095S

Dop op T handvat inch 9 delig  
Module 9 douille sur douille en pouce - poignées en T 



## FOR 5106B

Inbus-ballpoint L hendel 10 delig  
Module 10 clés mâles poignées en L

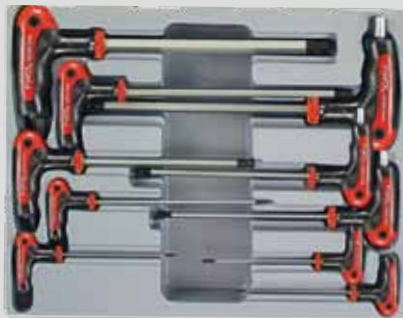

## FOR 50910BS

Inbus-ballpoint L hendel 9 delig inch  
Module 9 clés mâles poignées en L en pouce 

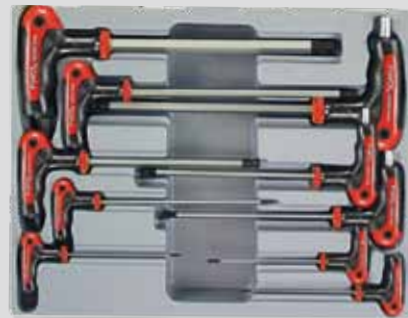

## FOR 2097

Inbussleutel op T handvat 9 delig  
Module 10 clés mâles poignées en T



## FOR 2097B

Inbus met bolkop op T handvat 9 delig  
Module 9 clés mâles poignées en T



## FOR 2097S

Inbus op T handvat 9 delig inch  
Module 9 clés mâles poignées en T tête sphér. en pouce 



## FOR 50912

T sleutels met inbus 9 delig  
Module 9 clés mâles poignées en T

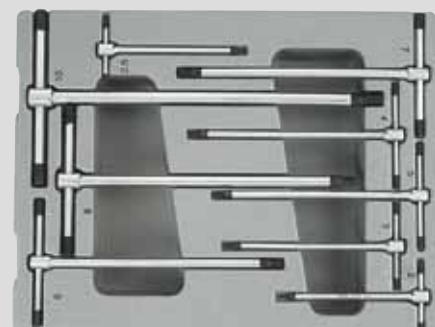

**FOR 2141**

Torx op T handvat 14 delig  
*Module 14 torx poignées en T*



**FOR 2141T**

Resistorx T handvat 14 delig  
*Module 14 resistorx poignées en T*



**FOR 51010T**

Resistorx op L handvat 10 delig  
*Module resistorx 10 pcs*



**FOR 2096**

Inwendige torx dop op T handvat 9 delig  
*Module 9 torx sur douille - poignées en T*



**FOR 2134**

Dopschroevendraaier 6k 13 delig  
*Modules 13 tournevis douilles*





## FOR 5048

Striptangenset 4 delig  
Module 4 pinces à sertir



## FOR 54111

Strip set 411 delig  
Module 411 pcs + pince à dénuder



## FOR 5138

Beitel-doorslagenset 13 delig  
Module 13 burins & poinçons gainés



## FOR 50713

Uitdeukset 7 delig  
Module kit de deblossage 7 pcs



## FOR 50816

Universeel cardangewrichtsleutels lang 8 delig  
Clés cardan universelles 8 pcs

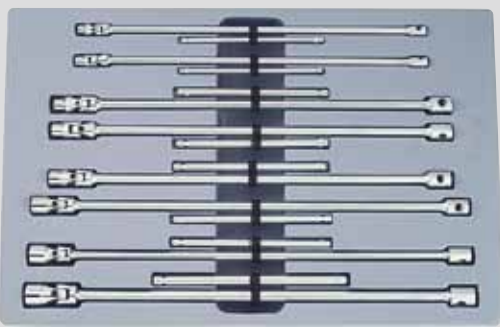

## FOR 50911

Halvemaansleutelset 9 delig  
Module 9 demi-lune

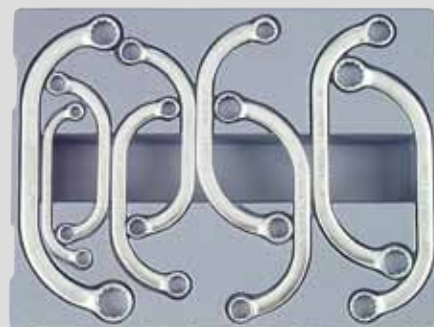

## FOR PPTSK130

Open doos voor TC module (38 x 14 mm x 4.5)  
TC module vide



## FOR PPVSK130

Deksel voor TC module  
Couvercle pour TC module



### Foam system

- ✓ ieder gereedschap zijn eigen plaats, dit zorgt voor een hogere productiviteit
- ✓ beter georganiseerd, snel toegankelijk
- ✓ chemisch bestendig schuim
- ✓ tweekleurig systeem, het valt direct op welke gereedschappen ontbreken
- ✓ het gereedschap blijft op zijn plaats tijdens het transport



**FOR 10225**  
**FOR 10217**  
**FOR 10218**  
 afmeting foam 57cm x 37 cm



**FOR 10318 Jumbo**  
 afmeting foam 74cm x 43 cm

### Foam system

- ✓ chaque outil à sa place, plus de productivité
- ✓ mieux organisé, avec facile
- ✓ visible ce qui manque par bi-couleur
- ✓ resiste au produits chimiques
- ✓ l'outillage rest en place pendant le transport

## FOR F2262

### Schroevendraaierset 26 delig

#### Module 26 tournevis

<b>713....serie</b>	3-3.5-4-5.5-6.5-8 mm
<b>713....S serie kort</b>	5.5-6.5 mm
<b>713... serie philips</b>	PH1-PH2-PH3
<b>713...S serie kort</b>	PH1-PH2
<b>716...serie Torx</b>	T5-T6-T8-T9-T10-T15-T20-T25-T27-T30-T40-T45



## FOR F2412

### Schroevendraaierset & L sleutel set 41 delig

#### Module tournevis & clés L 41 pcs

<b>713....serie</b>	3-4-5.5-6.5-8 mm
<b>713....S serie kort</b>	5.5-6.5 mm
<b>713... serie philips</b>	PH0-PH1-PH2-PH3
<b>713...S serie kort</b>	PH1-PH2
<b>716...serie Torx</b>	T10-T15-T20-T25-T27-T30-T40
<b>766...serie torx L</b>	T10-T15-T20-T25-T27-T30-T40-T45-T50
<b>764...serie inbus L</b>	1.5-2-2.5-3-4-5-6-7-8-10-12 mm



## FOR F2182

### Schroevendraaierset & tangen 1000v 18 delig

#### Module 18 tournevis & pinces 1000v

<b>7110N</b>	ph0 (60 mm L)
<b>7111N</b>	ph1 (80 mm L)
<b>7112N</b>	ph2 (100 mm L)
<b>7113N</b>	ph3 (150 mm L)
<b>713025N</b>	2.5 mm (75 mm L)
<b>71303N</b>	3 mm (100 mm L)
<b>713035N</b>	3.5 mm (100 mm L)
<b>71304N</b>	4 mm (100 mm L)
<b>713055N</b>	5.5 mm (125 mm L)
<b>713065N</b>	6.5 mm (150 mm L)
<b>71308N</b>	8 mm (175 mm L)
<b>6903180</b>	kombinatietang 180 mm L, pince universelle
<b>6904200</b>	lange bektang 200 mm L, pince à becs long
<b>6911200</b>	kniptang 200 mm L, pince coupante
<b>6912160</b>	striptang 160 mm L, pince à sertir
<b>6909250</b>	kabel snijder 250 mm
<b>6806</b>	striptang, pince a sertir
<b>88408</b>	Voltage tester 6-400v ac



## FOR F5117

### Tangenset 11 delig

#### Module 11 pincen

649250B	moersleutel, clé à molette 250 mm
613B250	waterpomptang, pince multiprise
614250	vise grip tang, pince grip
610B200	lange bektang, pince à becs long 200 mm
611B175	universele tang, pince universelle 175 mm
612B175	kniptang, pince coupante 175 mm
5047P1	lange bektang, pince à becs long
5047P2	lange bektang, pince à becs long 45°
5047P3	lange bektang, pince à becs long 90°
5047P4	multi tang 4 punts grip, pince multi grip
673B215	motortang, pince moteur



## FOR F51217

### Tangenset 12 delig

#### Module 12 pincen

610B200	lange bektang, pince à becs long 200 mm
610B200B	lange gebogen bektang, pince à becs long coudé 200 mm
611B175	kombinatietang, pince universelle 175 mm
612B175	kniptang, pince coupante 175 mm
614250	vise grip tang, pince grip 250 mm
613B250	waterpomptang, pince multiprise 250 mm
649250A	moersleutel, clé à molette 250 mm
609ASO	circlips tang, pince circlips 1.8 mm open
609ASC	circlips tang, pince circlips 1.8 mm gesloten
609ABO	circlips tang, pince circlips 1.8 mm 90° open
609ABC	borgveertang, pince circlips 1.8 mm 90° gesloten
6982	schaar, ciseau





## FOR F5155

### Tangen-hamerset 15 delig

#### Module pinces & marteaux 15 pcs

60226200C	koudbeitel 26 mm 200 mm L, burin
6044190	doorslag 4 mm 190 mm L, chasse goupilles
6046210	doorslag 6 mm 210 mm L
6074185	center punt 4 mm 185 mm L
613250	waterpomptang, pince multiprise
614250	vise grip tang, pince grip
610B200	lange bektang, pince à becs long 200 mm
611B175	universele tang, pince universelle 175 mm
612B175	kniptang, pince coupante 175 mm
609ASC	circlipstang 1.8 mm gesloten, pince circlips
609ASO	circlipstang 1.8 mm open, pince circlips
609ABO	circlipstang 1.8 90° open
609ABC	circlipstang 1.8 mm 90° gesloten
616A400	hamer 400gr, marteau
616F032	rivette hamer 32 mm, marteau rivette



## FOR F5207

### Tangen-beitelset 20 delig

#### Module pinces & burins 20 pcs

60226200C	koudbeitel 26 mm 200 mm L, burin
6044190	doorslag 4 mm 190 mm L, chasse goupille
6045200	doorslag 5 mm 200 mm L
6046210	doorslag 6 mm 210 mm L
6048215	doorslag 8 mm 215 mm L
60725185	center punt 2.5 mm 185 mm L
6074185	center punt 4 mm 185 mm L
6076185	center punt 6 mm 185 mm L
613B250	waterpomptang, pince multiprise
614250	vise grip tang, pince grip
610B200	lange bektang, pince à becs long 200 mm
610B200B	gebogen lange bektang 200 mm
611B175	universele tang, pince universelle 175 mm
612B175	kniptang, pince coupante 175 mm
649250	moersleutel 250 mm L, clé à molette
616300	hamer 300gr, marteau
616480	rubber hamer 400gr, marteau choutchouc



## FOR F31351

### Kombinatieset 135 delig 1/4" - 3/8"

#### Jeu de combinaison 135 pcs 1/4" - 3/8"

525 3.2.....14	1/4"	3.2-4-4.5-5-5.5-6-7-8-9-10-11-12-13-14 mm (korte doppen6k - douilles 6p)
52550 06.....13	1/4"	5-6-7-8-9-10-11-12-13 mm (lange doppen,douilles longues)
8042050...150	1/4"	verlengstuk, rallonges 50 mm-100 mm-150 mm
80521	1/4"	kniegewricht, cardan universelle
8032115	1/4"	wringstaaf
802215-802315	1/4"	ratel + ratel 3/8"
8143	1/4"	steekhecht, manche tournevis
81225	1/4"	magneet, aiment
326 32 08...40	1/4"	torx T8-T10-T15-T20-T25-T27-T30-T40
324 32 03...10	1/4"	inbus, hex 3-4-5-6-7-8-10 mm
321 321...323	1/4"	PH1-PH2-PH3
322 321...323	1/4"	PZ1-PZ2-PZ3
323 32 04...65	1/4"	plat 4.5 - 5 - 6.5 mm
535 06...22	3/8"	kort 6-7-8-9-10-11-12-13-14-15-16-17-18-19-20-21-22 mm
536 04...16	3/8"	E4-E5-E6-E7-E8-E10-E11-E12-E14-E16
53655 04...16	3/8"	E4-E5-E6-E7-E8-E10-E11-E12-E14-E16
53563 06...22	3/8"	lang 6-7-8-9-10-11-12-13-14-15-16-17-18-19-20-21-22 mm
33750 08...60	3/8"	resistorx T8H-T10H-T15H-T20H-T25H-T27H-T30H-T40H-T50H-T55H-T60H
33850 05...12	3/8"	spline M5-M6-M8-M9-M10-M12
33450 03...12	3/8"	inbus, hex 3-4-5-6-7-8-10-12 mm
765 03...10 mm		inbus, hex 1.27-1.5-2-2.5-3-4-5-6-8-10 mm
804375...150	3/8"	verlengstuk, rallonges 75 mm-150 mm
80531	3/8"	kniegewricht, cardan universelle
8033165	3/8"	Wringstaaf, manche en T
807316-807320.6	3/8"	bougiedop 16 mm-20.6 mm



## FOR F41083

### Kombinatieset 108 delig 1/4" - 1/2"

#### Jeu de combinaison 108 pcs 1/4" - 1/2"

525 4....13	1/4"	4-4.5-5-5.5-6-7-8-9-10-11-12-13 mm (korte doppen)
52550 06....13	1/4"	6-7-8-9-10-11-12-13 mm (lange doppen)
526 04....10	1/4"	E4-E5-E6-E7-E8-E10 (inwendig torx)
545 10....32	1/2"	10-11-12-13-14-15-16-17-18-19-21-22-24-27-30-32 mm (korte doppen)
54577 14....22	1/2"	14-15-17-19-22 mm (lange doppen)
546 12....24	1/2"	inwendig torx E12-E14-E16-E18-E20-E24
321 321...323	1/4"	PH1-PH2-PH3
322 321...323	1/4"	PZ1-PZ2-PZ3
323 3204...65	1/4"	plat 4-5-5-6.5 mm
324 32 03....08	1/4"	inbus 3-4-5-6-7-8 mm
326 32 08....40	1/4"	torx T8-T10-T15-T20-T25-T27-T30-T40
327 32 08....40	1/4"	resistorx TX8-TX10-TX15-TX20-TX25-TX30-TX40
5116 inbusset		1.5-2-2.5-3-4-5-6-7-8-10-12 mm
802220-802215	1/4"	2 ratel, cliquet
8024415	1/2"	ratel, cliquet
8032115-8034250	1/4"	1/4" - 1/2" wringstaaf, manche en T
8042 50....100	1/4"	verlengstuk, rallonges 50 mm-100 mm
8044 125...250	1/2"	verlengstuk, rallonges 125 mm-250 mm
8143	1/4"	steekhecht, manche tournevis
80521-80541	1/4"	kniegewricht, cardan universelle
80541	1/2"	kniegewricht, cardan universelle
81225	1/4"	magneet pick up, aiment

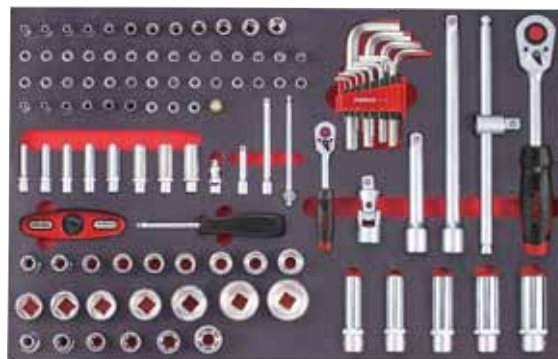

## FOR F4451

### 1/2" Kombinatieset 45 delig

#### Jeu de combination 1/2" 45 pcs

5455 8....32 6k doppen	1/2"	douilles 8-9-10-11-12-13-14-15-16-17-18-19-20-21-22-23-24-26-27-28-30-32 mm
545577 10....32 6k lange doppen	1/2"	douilles longues 10-12-13-14-15-17-19-21-22-23-24-30-32 mm
80242	1/2"	ratel, cliquet
8044125..250	1/2"	2 verlengstukken, rallonges 125 mm-250 mm
8014380	1/2"	wringstaaf met kniestuk, manche flex
80541	1/2"	kniegewricht, cardan univeselle
8034250	1/2"	wringstaaf, manche en T
609ASC		borgveertang, pince circlips
609ABO		borgveertang, pince circlips
609ASO		borgveertang, pince circlips
609ABC		borgveertang, pince circlips



## FOR F4882

### 1/4" - 3/8" - 1/2" doppenassortiment 88 delig

#### Jeu de douilles 88 pcs 1/4" - 3/8" - 1/2"

525 3.2.....14	1/4"	3.2-4-4.5-5-5.5-6-7-8-9-10-11-12-13 mm (korte doppen)
52550 06....13	1/4"	6-7-8-10 mm (lange doppen, douilles longues)
8042050...150	1/4"	verlengstuk, rallonges 50 mm-100 mm-150 mm
802215	1/4"	ratel, cliquet
80521	1/4"	kniegewricht, cardan universelle
8032115	1/4"	wringstaaf, manche en T
8143	1/4"	steekhecht, manche tournevis
81225	1/4"	magneet, aimant
53563 06....22	3/8"	8-9-10-11-12-13-14-15-16-17-18-19 mm
53563 06....22	3/8"	8-9-10-12-13-14 mm
802315	3/8"	ratel, cliquet
	3/8"	adapter voor verlengstuk
804375...150	3/8"	verlengstuk, rallonges 75 mm-150 mm
80531	3/8"	kniegewricht, cardan universelle
8033165	3/8"	Wringstaaf, manche en T
807314M	3/8"	bougiedop 14 mm magnetisch
807316M	3/8"	bougiedop 16 mm magnetisch
807318M	3/8"	bougiedop 18 mm magnetisch
807320.6M	3/8"	bougiedop 20.6 mm magnetisch
545 10...32 doppen 6k	1/2"	10-11-12-13-14-15-16-17-18-19-20-21-22-23-24-26-27-28-30-32 mm
54577 13 ...32	1/2"	13-14-15-17-19-21-22-24-27-30-32 mm 77 mm L
802415	1/2"	ratel, cliquet
8044125 8044250	1/2"	verlengstukken, rallonges 125 mm-250 mm
80541	1/2"	kniegewricht, cardan universelle
80634	1/2"	adapter 3/8"*1/2"



## FOR F41041

### Doppen torx assortiment 1/4"-3/8"-1/2"104 delig Jeu de douilles - torx 104 pcs

526 4...10	1/4"	E4-E5-E6-E7-E8-E10
52650 04...10	1/4"	E4-E5-E6-E7-E8-E10 50 mm L
32632 08...30	1/4"	Torx op dop T8-T9-T10-T15-T20-T25-T27-T30
32F32 10...40	1/4"	Vijfkant TS10-TS15-TS20-TS25-TS27-TS30-TS40
80923	1/4"	Adapter 1/4"*3/8"
33F50 45-50	3/8"	vijfkant TS45-TS50
536 06...12	3/8"	E06-E8-E10-E12
546 11...24	1/2"	E11-E12-E14-E16-E18-E20-E22-E24
546577 11...24	1/2"	E11-E12-E14-E16-E18-E20-E22-E24 77 mm L
34655 40...70	1/2"	T40-T45-T47-T50-T55-T60-T70 55 mm L
3467080	1/2"	T80 70 mm L
346100 20...100	1/2"	T20-T25-T27-T30-T40-T45-T50-T55-T60-T70-T90-T100 100 mm L
34614060	1/2"	T60 140 mm L
34710055	1/2"	Resistorx T55 100 mm L
34710570	1/2"	Resistorx T70 105 mm L
34713030	1/2"	Resistorx T30 130 mm L
34714080	1/2"	Resistorx T80 140 mm L
80546 14...24	1/2"	Dop met kniegewricht E14-E16-E18-E20-E24
80943	1/2"	adapter 1/2"*3/8"
756 0608A...2024A		Torx sleutel 75° E6xE8-E10xE12-E14xE18-E20xE24
5098LT		Resistorx L sleutel T10H-T15H-T20H-T25H-T27H-T30H-T40H-T45H-T50H
50913		Vijfkant met gat TS10-TS15-TS20-TS25-TS27-TS30-TS40-TS45-TS50

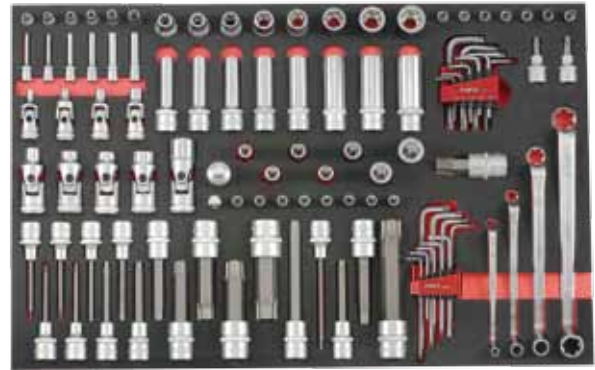



## FOR F5351

**Sleutelset 35 delig**  
*Jeu de clés 35 pcs*

<b>755 serie steekring clés mixtes</b>	6-7-8-9-10-11-12-13-14-15-16-17-18-19-21-22-23-24-26-27-28-30-32 mm
<b>759 serie gebogen ringsleutel</b>	6x7-8x9-10x11-12x13-14x15-16x17-18x19-21x22-23x26-24x27-25x28-30x32 mm



## FOR F5421

**Sleutelset 42 delig**  
*Jeu de clés 42 pcs*

<b>755 serie steekring clés mixtes</b>	6-7-8-9-10-11-12-13-14-15-16-17-18-19-20-21-22-23 mm
<b>754 serie steeksleutel clés plates</b>	6x7-8x9-10x11-x12x13-14x15-16x17-18x19-20x22-21x23-24x27-30x32 mm
<b>758 serie gebogen ringsleutels</b>	8x9-10x11-12x13-14x15-16x17-18x19-21x23-22x24 mm
<b>751 serie open ring sleutels</b>	9x11-x10x12-12x14-14x17-17x19 mm

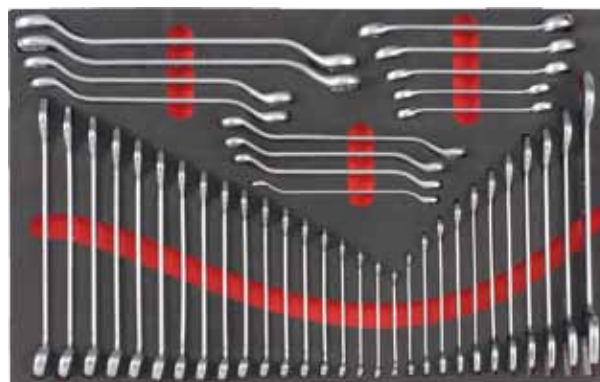

## FOR F5361

**Sleutelset 36 delig**  
*Jeu de clés 36 pcs*

<b>755 serie steekring clés mixtes</b>	6-7-8-9-10-11-12-13-14-15-16-17-18-19-21-22-23-24-26-27-28-30-32 mm
<b>759 serie gebogen ringsleutel</b>	6x7-8x9-10x11-12x13-14x15-16x17-18x19-21x22-23x26-24x27-25x28-30x32 mm



## FOR F5182

### Beitel & hamerset 18 delig Burins & marteaux 18 pcs

602 12150Q...22200Q	beitels, burins 12-15-19-22 mm
603150q	kapbeitel, bédane
604 2140Q...8215Q	doorslagen, chasse-goupilles 2-3-4-5-6-8 mm
6066185Q	puntslag, pointeau 6 (185 mm L)
6076185Q	centerpunt, pointeau 6 (185 mm L)
5055P1	schaar, ciseau
5055P4	cuttermes, couteau universel
616300	hamer, marteau 300 gr
616400	rubber hamer, marteau caoutchouc 400 gr
66303	zaag, scie



## FOR F5186

### Assortiment vijlen en acc. 18 delig Jeu de limes & acc. 18 pcs

5056P1	platte vijl - lime plat
5056P2	halfronde vijl - lime demi ronde
5056P3	ronde vijl - lime ronde
5056P4	vierkantsvijl - lime carré
5056P5	driehoeksvijl - lime triangle
5055p4	universeel mes - couteau universel
66303	mini zaag - scie
6981250	alles snijder - couteau
5056P1	schuifmlaat - pied à coulisse
5096P4	hoekmeter - rapporteur inox
	stalen borstel
5096P7	stalen kraspen - pointe à tracer
5096P8	meter 5 m - mètre à ruban
5096P2	center punt - pointeau
5096P5	voelermaatjes - jauge d'épaisseur
5096P6	voelermaatjes Inch - jauge d'épaisseur
5096P3	liniaal 30cm, règle métal



## FOR F4175

Slagmoerset 1/2" - 17 delig

Jeu de douilles à choc 1/2" - 17 pcs

445 13....24	slagdoppen, douilles à chocs 1/2" 13-14-15-16 17-18-19-21-22-24 mm
44585 17...21C	alu doppen 1/2" 17-19-21 mm
6474535	1/2" momentsleutel, clé dynamométrique 40-210nw
825A41	slagmoersleutel op batterij + lader
6821	wielgewichttang, pince pour masses



## FOR F2195

Inbussleutelset - dop op handvat 19 delig

Jeu de douilles à poignée en T & clés hex 19 delig

744300 05....13	5-6-7-8-9-10-11-12-13 mm (300 mm L)
765 2G...12G	inbus 2-2.5-3-4-5-6-7-8-10-12 mm



## FOR F6213

Doppenset 3/4" 6k - 21 delig

Jeu de douilles 6 pans 3/4" - 21 pcs

565 19...50 6k doppen	douilles 6p 19-21-22-23-24-26-27-29-30-32-35- 36-38-41-46-50 mm
8046100	verlengstuk, rallonge 100 mm
8046200	verlengstuk, rallonge 200 mm
8026500	ratel, cliquet 500 mm
80968	adapter, adaptateur



**Jumbo**
**FOR F2452 - Jumbo**

Schroevendraaierset 45 delig

Jeu de tournevis 45 pcs

7111S-7112S	PH1-PH2 (25 mm L)
7110 - 7111	PH0 (60 mm L) - PH1 (60 mm L)
7112 - 7113	PH2 (100 mm L) - PH3 (150 mm L)
713055S-713065S	5.5 mm (25 mm L)-6.5 mm (25 mm L)
71303-713035	3 mm (75 mm L) - 3.5 mm (100 mm L)
71304-713055	4 mm (100 mm L) - 5.5 mm (125 mm)
713065-71308	6.5 mm (150 mm L) - 8 mm (175 mm L)
655306 - 65512	6 mm extra lang 400 mm - PH2 extra lang 450 mm
716 05...45 torx	T5-T6-T7-T8-T10-T15-T20-T25-T27-T30-T40-T45
717 06...60 resistorx L sleutel set	T6H-T7H-T8H-T9H-T10H-T15H-T20H-T25H-T27H-T30H-T40H-T45H
88601	magnetiseur-demagnetiseur

**FOR F2335 - Jumbo**

Schroevendraaierset 33 delig

Jeu de tournevis 33 pcs

7111S-7112S	PH1-PH2 (25 mm L)
7110 - 7111	PH0 (60 mm L) - PH1 (60 mm L)
7112 - 7113	PH2 (100 mm L) - PH3 (150 mm L)
713055S-713065S	5.5 mm (25 mm L)-6.5 mm (25 mm L)
71303-713035	3 mm (75 mm L) - 3.5 mm (100 mm L)
71304-713055	4 mm (100 mm L) - 5.5 mm (125 mm)
713065-71308	6.5 mm (150 mm L) - 8 mm (175 mm L)
FOR 88601	magnetiseur-demagnetiseur
716 05...45 torx	T5-T6-T7-T8-T10-T15-T20-T25-T27-T30-T40-T45
905M2P1 ... 905M2P5	5 clipsverwijderaars, grattoirs et crochets

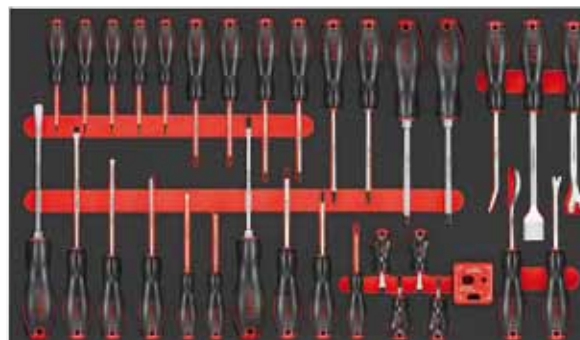
**FOR F2592 - Jumbo**

Schroevendraaierset 59 delig

Jeu de tournevis 59 pcs

7111S-7112S	PH1-PH2 (25 mm L)
7110 - 7111	PH0 (60 mm L) - PH1 (60 mm L)
7112 - 7113	PH2 (100 mm L) - PH3 (150 mm L)
713055S-713065S	5.5 mm (25 mm L)-6.5 mm (25 mm L)
71303-713035	3 mm (75 mm L) - 3.5 mm (100 mm L)
71304-713055	4 mm (100 mm L) - 5.5 mm (125 mm)
713065-71308	6.5 mm - 8 mm -10mm -12mm
FOR 88601	magnetiseur-demagnetiseur
716 05...45 torx	T5-T6-T7-T8-T10-T15-T20-T25-T27-T30-T40-T45
	Haakse XL kogelinbus sleutels 1.5-2-2.5-3-4-5-6-7-8-10-12 mm
	Haakse XL resistorx sleutels T10H-T15H-T20H-T25H-T27H-T30H-T40H-T45H-T50H
	Haakse 5-kant Resistorx TS sleutels TS10-TS15-TS20-TS25-TS27-TS30-TS40-TS45-S50

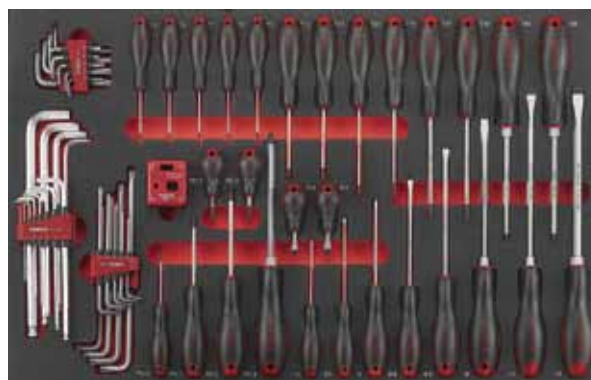



## FOR F21251 - Jumbo

Doppen 1/4" & tangenset 125 delig

Jeu de douilles 1/4" & de pincen 125 pcs

525 032....13 dop 1/4	3.2-4-4.5-5-5.5-6-7-8-9-10-11-12-13 mm
5255 004...13 lang	4-4.5-5-5.5-6-7-8-9-10-11-12-13 mm
5260 4...10	E4-E5-E6-E7-E8-E10 korte inwendig torx
5265 04...10	E4-E5-E6-E7-E8-E10 lang inwendig torx
321 320...323	1/4" PH0-PH1-PH2-PH3
322 320...323	1/4" PZ0-PZ1-PZ2-PZ3
323 32 04...32065	1/4" plat 4-5.5-6.5 mm
324 32 04...10	1/4" inbus 3-4-5-6-7-8-10 mm
326 32 08...10	1/4" torx T8-T10-T15-T20-T25-T27-T30-T40
327 32 08...40	1/4" resistorx T8H-T10H-T15H-T20H-T25H-T27H-T30H-T40H
32F3210....40	TS10-TS15-TS20-TS25-TS27-TS30-TS40
5116L 765 01.5L....765 012L	inbus L sleutel set 1.5-2-2.5-3-4-5-6-7-8-10-12 mm



802223	1/4" ratel, cliquet
802215	1/4" ratel, cliquet
802220	1/4" mini ratel, cliquet mini
8032115	1/4" wringstaaf, manche en T
81225	magneet pick up, aiment
8143	steekhecht, manche tournevis
8111	flexibel verlengstuk, rallonge flex
8042 50-100-150-250	1/4" verlengstuk, rallonge 50-100-150-250 mm
80521	kniegewricht, cardan universelle
6472300W	1/4" momentsleutel, clé dynamom. 6-30nw
6472150	1/4" momentsleutel, clé dynamom.
50814P1 tot P8	8 mini tangen, pince mini
	schaar/pincet/precisiemes
11 precisie schroev.	PH000-PH00 plat 1.0-1.2-1.5-1.8-2.0-2.4 mm
	inbus, hex 0.9-1.3-1.5 mm

## FOR F31921- Jumbo

Doppen 1/4"-3/8" kombinatieset 192 delig

Jeu de douilles 1/4" - 3/8" 192 pcs

525 032....13 dop 1/4	4-4.5-5-5.5-6-7-8-9-10-11-12-13 mm
5255 004...13 lang	4-4.5-5-5.5-6-7-8-9-10-11-12-13 mm
5260 4...10	E4-E5-E6-E7-E8-E10 korte inwendig torx
5265 04...10	E4-E5-E6-E7-E8-E10 lang inwendig torx
321 320...323	1/4" PH0-PH1-PH2-PH3
322 320...323	1/4" PZ0-PZ1-PZ2-PZ3
323 32 03...32065	1/4" plat 3-4-5-5.5-6.5 mm
324 32 04...08	1/4" inbus 3-4-5-6-7-8mm
326 32 08...10	1/4" torx T8-T9-T10-T15-T20-T25-T27-T30-T40
327 32 08...40	1/4" resistorx T8H-T9H-T10H-T15H-T20H-T25H-T27H-T30H-T40H
32F3210....40	TS10-TS15-TS20-TS25-TS27-TS30-TS40

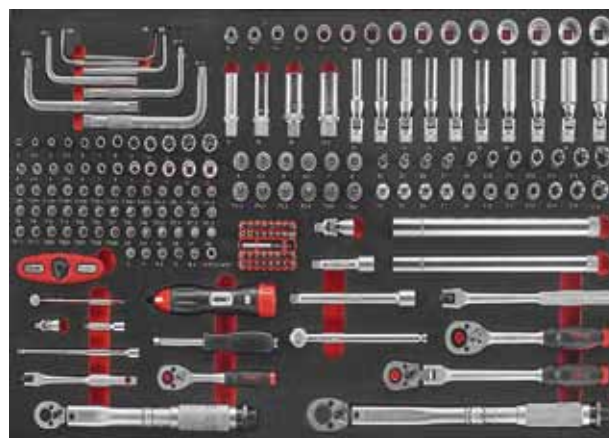

80222	1/4" ratel, cliquet
802220	1/4" mini ratel, cliquet mini
6472270	1/4" momentsleutel 5-25nw
64721608	1/4" momentsleutel 1-8Nm
8032115	1/4" wringstaaf, manche en T
8012140	1/4" wringstaaf met kniegewricht
	bithouder
8143	steekhecht, manche tournevis
8042 50-150	1/4" verlengstuk, rallonge 50-150 mm
80521	kniegewricht, cardan universelle
2331	security bitset 33dlg
haakse XZN sleutels	M5-M6-M8-M10-M12-M14-M16

539 08...22 doppen 3/8"	8-9-10-11-12-13-14-15-16-17-18-19-20-21-22mm (12kant)
805358 10...19 kniegewricht doppen 3/8"	10-11-12-13-14-15-16-17-18-19mm
536 04...18 torx doppen kort	E4-E5-E6-E7-E8-E10-E11-E12-E14-E16-E18
53655 04...18 torx lang	E4-E5-E6-E7-E8-E10-E11-E12-E14-E16-E18
331503 331504	PH3-PH4
332503 332504	PZ3-PZ4
333500 5...8	5-5.5-6-6.5-7-8mm
80232	3/8" ratel 24t
802318	3/8" flexibele ratel 30t
6473365	3/8" momentsleutel 19 -210nw
8013215	3/8" wringijzer 215mm
8043075-8043150	verlengstukken 75-150mm
8033165	3/8" t hendel
80521	3/8" kniegewricht
8073 14...20.6	3/8" bougiedoppen 14-16-18-20.6MM
8073250 14 - 16	3/8" bougiedoppen 14-16mm (250mml)

## FOR F41621 - Jumbo

Kombinatieset 1/4"-3/8"-1/2" 162 delig

Jeu de combinaison 1/4"-3/8"-1/2" 162 pcs

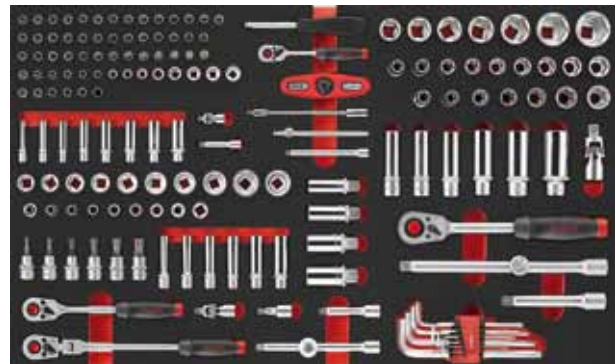

525 3.2...14	1/4" doppen kort 3.2-4-4.5-5-5.5-6-7-8-9-10-11-12-13-14 mm
525500 06...13	1/4" doppen lang6-7-8-9-10-11-12-13 mm
526 04...10	inwendig torx E4-E5-E6-E7-E8-E10
321 320...323	1/4" PH0-PH1-PH2-PH3
322 320...323	1/4" PZ0-PZ1-PZ1*PZ3
323 3204...065	1/4" plat 3-4-5-5-6.5 mm
324 3203...10	1/4" inbus 3-4-5-6-7-8-9-10 mm
326 3208...40	1/4" torx T8-T9-T10-T15-T20-T25-T27-T30-T35-T40
327 3208... 40	1/4" resistorx T8H-T10H-T20H-T25H-T27H-T30H-T35H-T40H
802215	1/4" ratel
802220	1/4" ratel mini
8032115	1/4" wringstaaf
8042050 - 8042100	1/4" verlengstuk 50 + 100 mm
8111	1/4" flexibel verlengstuk
8143	1/4" steekhecht, mache tournevis
80521	1/4" kniegewricht
81225	1/4" magneet, aimant
535 06...24	3/8" doppen 6-7-8-9-10-11-12-13-14-15-16-17-18-19-20-21-22-23-24 mm
53563 08...14	3/8" lange doppen 8-9-10-12-13-14 mm
802315	3/8" ratel
802318	3/8" flexibele ratel
8043075 - 8043150	3/8" verlengstuk 75 mm & 150 mm
8043044W	3/8" verlengstuk 44 mm
80531	3/8" kniegewricht
80643	adapter voor verlengstuk 1/2" x 3/8"
807314	3/8" bougie dop 14 mm
807316	3/8" bougie dop 16 mm
807318	3/8" bougie dop 18 mm
807320.6	3/8" bougie dop 20.6 mm
3385005...12	3/8" spline dop (12k) M5-M6-M8-M9-M10-M12
545 10...32 6k doppen 6 pans	1/2" 10-11-12-13-14-15-16-17-18-19-21-22-23-24-27-30-32 mm (douilles)
54577 10...32 6k lange doppen	1/2" 14-15-17-19-22-24 mm (douilles longues)
546 10...24	1/2" E12-E14-E16-E18-E20-E22-E24 (kort)
802415	1/2" ratel, cliquet 36t
80541	1/2" kniegewricht, cardan universeel
80634	adapter voor verlengstuk 3/8" x 1/2"
8044 125-250	1/2" 2 verlengst, rallonges 125 mm-250 mm
81047	bithouder 1/2" * 10 mm porte embouts
inbus - hex	1.27-1.5-2-2.5-3-4-5-6-8-10 mm

## FOR F41491 - Jumbo

### Kombinatieset 1/2" 149 delig

#### Jeu de combination 1/2" 149 pcs

<b>545 10....32</b> <b>6k doppen 6 pans</b>	10-11-12-13-14-15-16-17-18-19-20-21-22-23-24-26-27-28-30-32 mm (douilles)
<b>54577 10....32</b> <b>6k lange doppen</b>	10-11-12-13-14-15-16-17-18-19-20-21-22-23-24-26-27-28-30-32 mm (douilles longues)
<b>546 10....24</b>	E10-E11-E12-E14-E16-E18-E20-E22-E24 (kort)
<b>546 5504...18</b>	E10-E11-E12-E14-E16-E18-E20-E24 (lang)
<b>174 30 04...12</b>	4-5-6-7-8-10-12 mm (inbus torx kort bits)
<b>174 75 04...12</b>	4-5-6-7-8-10-12 mm (inbus torx lang bits)
<b>176 30 20...60</b>	T20-T25-T27-T30-T40-T45-T50-T55-T60 L30 mm
<b>176 75 20...60</b>	T20-T25-T27-T30-T40-T45-T50-T55-T60 L75 mm
<b>176 120 40...55</b>	T40-T45-T50-T55 (L120 mm)
<b>177 30 20...60</b>	T20H-T25H-T27H-T30H-T40H-T45H-T50H-T55H-T60H (L30 mm)
<b>177 75 20...60</b>	T20H-T25H-T27H-T30H-T40H-T45H-T50H-T55H-T60H (L75 mm)
<b>178 30 05...12</b>	M5-M6-M8-M10-M12 (L30 mm)
<b>178 75 05...12</b>	M5-M6-M8-M10-M12(L75 mm)
<b>179 30 04...14</b>	M4-M5-M6-M8-M9-M10-M12-M13-M14 (kort)
<b>179 75 04...14</b>	M4-M5-M6-M8-M9-M10-M12-M13-M14 (lang)
<b>802415</b>	ratel, cliquet 36t
<b>80541</b>	kniegewricht, cardan universeel
<b>8034250</b>	wringstaaf, manche en T
<b>8044 075-125-250</b>	3 verlengstukken, rallonges 75 mm-125 mm-250 mm
<b>81047</b>	bitouder 1/2" * 10 mm porte embouts



## FOR F41162 - Jumbo

### Kombinatieset 3/8" - 1/2" 116 delig

#### Jeu de combination 3/8" - 1/2" 116 pcs

<b>545 10....32</b> <b>6k doppen 6 pans</b>	10-11-12-13-14-15-16-17-18-19-20-21-22-23-24--25-26-27-28-30-32 mm (douilles)
<b>54577 10....32</b> <b>6k lange doppen</b>	14-15-16-17-18-19-20-21-22-23-24-25-26-27-28-30-32 mm (douilles longues)
<b>546 10....24</b>	E8-E10-E11-E12-E14-E16-E18-E20-E22-E24
<b>344050 05...19</b>	5-6-4-8-9-10-12-14-17mm (50mmL) inbus
<b>344100 05...14</b>	5-6-7-8-9-10-12-14mm (100mmL) inbus
<b>346055 27..70</b>	T27-T30-T40-T45-T50-T55-T60-T70 (55mmL)
<b>346100 27...70</b>	T27-T30-T40-T45-T50-T55-T60-T70 (100mmL)
<b>347055 30...70</b>	T30H-T40H-T45H-T50H-T55H-T60H-T70H (55mmL) resistorx
<b>348055 05...18</b>	M5-M6-M8-M9-M10-M12-M14-M16-M18 (55mmL) XZN
<b>348100 05...18</b>	M5-M6-M8-M9-M10-M12-M14-M18 (100mmL)
<b>34805516T</b>	M16 met gat (55mmL) voor VAG
<b>34810016T</b>	M16 met g gat (100mmL) voor VAG
<b>8014380</b>	schuifbar 380mmL
<b>80242</b>	ratel, cliquet 24t
<b>80541</b>	kniegewricht, cardan universeel
<b>8034250</b>	wringstaaf, manche en T
<b>8044 125-250</b>	2 verlengstukken, rallonges 125 mm-250 mm

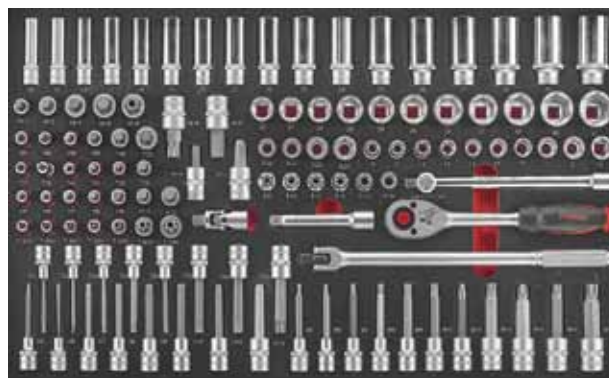

## FOR F5481 - Jumbo

**Sleutelset 48 delig**  
*Jeu de clés 48 pcs*

<b>755 serie steekringsleutels</b> clés mixtes	6-7-8-9-10-11-12-13-14-15-16-17-18-19-21-22-23-24-26-27-28-30-32 mm
<b>759 serie gebogen ringsleutel</b> clés polygonales	6x7-8x9-10x11-12x13-14x15-16x17-18x19-21x23-20x22-23x26-24x27-25x28-30x32 mm
<b>757 08...19F</b> flexibele ringratel clés mixte cliquet	8-9-10-11-12-13-14-15-16-17-18-19 mm

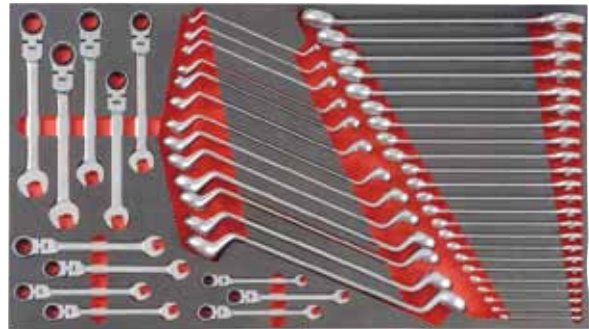

## FOR F5505 - Jumbo

**Sleutelset 50 delig**  
*Jeu de clés 50 pcs*

<b>755 serie steekringsleutels</b> clés mixtes	6-7-8-9-10-11-12-13-14-15-16-17-18-19-20-21-22-23-24-25-26-27-28-30-32 mm
<b>759 serie gebogen ringsleutel</b> clés polygonales	6x7-8x9-10x11-12x13-14x15-16x17-18x19-20x22-21x23-24x27-25x28-30x32 mm
<b>754 0607...3032</b> steeksleutels clés à fourche	6x7-8x9-10x11-12x13-14x15-16x17-18x19-20x22-21x23-24x27-25x28-30x32 mm

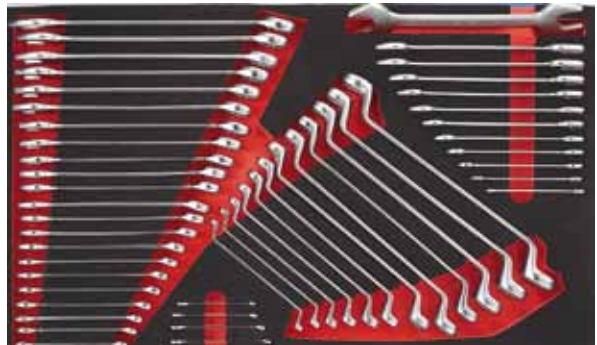

## FOR F5461 - Jumbo

**Sleutelset 46 delig**  
*Jeu de clés 46 pcs*

<b>757 serie steek-ratel</b>	8-9-10-11-12-13-14-15-16-17-18-19 mm
<b>760 serie XL</b>	8x10-12x14-13x15-16x18-17x19-21x23-22x24 mm
<b>755S serie mini</b>	8-9-10-11-12-13-14-15-16-17-18-19 mm
<b>751 serie open ringsleutels</b>	8x10-9x11-12x13-14x15-16x18-17x19-19x22-24x27-30x32 mm
<b>756 serie torxsleutels</b>	E6xE8-E7xE11-E10xE12-E14xE18-E16xE22-E20xE24

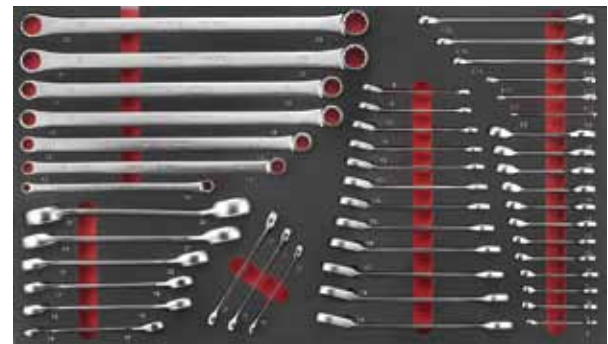



## Foamsets 10323 - 10318 Jumbo

### FOR F5173 - Jumbo

#### Tangenset 17 delig

##### Jeu de pinces 17 pcs

609ASC	borgveertang, pince circlips
609ASO	borgveertang, pince circlips
609ABC	borgveertang, pince circlips
609ABO	borgveertang, pince circlips
610B200	lange bektang, pince à becs long 200 mm
610B200B	gebogen lange bektang, pince à becs long coudé 200 m
611B175	kombinatietang, pince universelle 175 mm
612B175	kniptang, pince coupante 175 mm
613B250	waterpomptang, pince multiprise 250 mm
614250	vise grip tang, pince grip 250 mm
65202	schuine vise grip tang, pince étai à becs coudé
649250A	moersleutel, clé à molette 250 mm
6805	striptang, pince à sertir
6923160	kabelsnijtang, coupe câble
6921160	4 in 1 electrical tang
673B215	universele rondebek tang
6925160	kniptang 160 mm

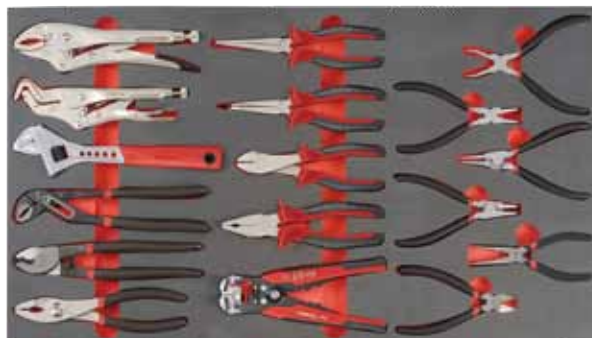

### FOR F5188 - Jumbo

#### Tangenset 18 delig

##### Jeu de pinces 18 pcs

609ASC	borgveertang, pince circlips
609ASO	borgveertang, pince circlips
609ABC	borgveertang, pince circlips
609ABO	borgveertang, pince circlips
610B200	lange bektang, pince à becs long 200 mm
610B200B	gebogen lange bektang, pince à becs long coudé 200 m
611B175	kombinatietang, pince universelle 175 mm
612B175	kniptang, pince coupante 175 mm
613B250	waterpomptang, pince multiprise 250 mm
614250	vise grip tang, pince grip 250 mm
65202	schuine vise grip tang, pince étai à becs coudé
649250E	moersleutel, clé à molette 250 mm
5047P1	lange bektang, pince à becs long
5047P2	lange bektang, pince à becs long 45°
5047P3	lange bektang, pince à becs long 90°
5047P4	multi tang 4 punts grip, pince multi grip
673B215	universele rondebek tang
649200C	moersleutel 38 mm opening



### FOR F5296 - Jumbo

#### Tangenset 29 delig

##### Jeu de pinces 29 pcs

609ASC	borgveertang, pince circlips
609ASO	borgveertang, pince circlips
609ABC	borgveertang, pince circlips
609ABO	borgveertang, pince circlips
610B200	lange bektang, pince à becs long 200 mm
610B200B	gebogen lange bektang, pince à becs long coudé 200 m
611B175	kombinatietang, pince universelle 175 mm
612B175	kniptang, pince coupante 175 mm
613B250	waterpomptang, pince multiprise 250 mm
614250	vise grip tang, pince grip 250 mm
6805	automatische striptang
649250	moersleutel, clé à molette 250 mm
616300	bankhamer 300gr
616400	rubber hamer 400gr
	voelermaatjes 20dlg
	monteurs mes
	center punt 4mm
	kapbeitel
	beitels plat 12-19-25mm
	pendrijvers 2-3-4-5-6-8-10mm
	pakking schraper



## FOR F5242 - Jumbo

### Hamer & beiterset 24 delig Jeu de burins & acc. 24 pcs

602 12150Q...22200Q	10-12-15-19-22-25 mm beitels, burins
603150Q	kapbeitel, bédane
604 2140Q...8215Q	2-3-4-5-6-8 mm puntslag, pointeau
606 ....	4-5-6 mm puntbeitel
616300	hamer, marteau 300 gr
616280	rubber hamer, marteau caoutchouc 280 gr
5055P4	mes, couteau
5096P8	meter, mètre à ruban 5m
6982	schaar, ciseaux
5055P1	metaalplaatschaar, ciseau pour métal
66302	mini zaag, scie mini



## FOR F5352 - Jumbo

### Vijl & meetset 35 delig

#### Outils de mesure 35 pcs

5055p4	universeel mes- couteau universel
5056P1	platte vijl, lime plat
5056P2	half ronde vijl, lime demi rond
5056P3	ronde vijl, lime ronde
5056P4	vierkants vijl, lime quarré
5056P5	driehoeksvijl, lime triangle
8174	slagschroevendraaier + 12 bits, tournevis à frapper
63005	linkse tappenset, extracteurs
5096P1	schuifmaat, pied à coulisse
5096P2	kraspen, pointe à tracer
5096P3	stalen meetlat 30cm
5096P4	gradenboog, rapporteur
5096P5	voelermaatjes, jauges d'épaisseur 0.25-6 mm
5096P6	voelermaatjes, jauges d'épaisseur 4-62 inch
5096P7	stalen naald
5096P8	meter 5m
61802	voelermaatjes, jauges d'épaisseur mm+inch
66303	hakzaag
6981250	snij-kniptang
9U3003	staalborstel
60212150	beitel 12 150 mmL
60221150C	platte beitel 21x150L
60226200C	platte beitel 26x200L
603150	kapbeitel 150 mmL
604 serie	doorslagen 2-3-4-5-6-8 mm
6063185	puntbeitel m 185 mmL
6074185	center punt 4 185 mmL
616300	hamer 300gr
616A400	hamer nylon 400gr
617L	telescopische lamp met spiegel, miroir
6983	schaar
87901	stalen potlood



## FOR F5292 - Jumbo

### Sleutel-haakset 29dlg

#### Jeu de clés 29pcs

905M2P1	vork voor deurbekleding
905M2P2	schraper plat
905M2P3	schraper
905M2P4	schraper gebogen
905M2P5	haak algemeen gebruik
905M1	Clipverwijderaars 5dlg
774300 06...14	6-7-8-9-10-11-12-13-14mm T greep dopsleutels
765 02....12	2-2.5-3-4-5-6-7-8-10-12mm L greep kogelbus sleutels



## FOR F5521 - Jumbo

### Vijl & meetset 52 delig

#### Outils de mesure 52 pcs

751 serie open ringsleutel	8x10-9x11-11x13-12x14-14x17-16x18-17x19-24x27-30x32 mm
5056P1	platte vijl, lime plat
5056P2	half ronde vijl, lime demi rond
5056P3	ronde vijl, lime ronde
5056P4	vierkants vijl, lime quarré
5056P5	driehoeksvijl, lime triangle
8174	slagschroevendraaier + 12 bits, tournevis à frapper
63005	linkse tappenset, extracteurs
5096P1	schuif mm, pied à coulisse
5096P2	kraspen, pointe à tracer
5096P3	meetlat, règle
5096P4	gradenboog, rapporteur
5096P5	voelermaatjes, jauges d'épaisseur 0.25-6 mm
5096P6	voelermaatjes, jauges d'épaisseur 4-62 inch
61802	voelermaatjes, jauges d'épaisseur mm+inch
68602	lamp, lampe
6720912...1622	nut splitter 09-12 mm/12-16 mm/16-22 mm
617L	telescopische lamp met spiegel, miroir



## FOR F4491 - Jumbo

### Slagmoerset 1/2" 49 delig

#### Jeu de douilles à chocs & acc. 1/2" 49 pcs

445 10...32 kort	1/2" 10-11-12-13-14-15-16-17-18-19-20-21-22-23-24-26-27-28-30-32 mm
44585 10...32 lang	1/2" 10-11-12-13-14-15-16-17-18-19-20-21-22-23-24-26-27-28-30-32 mm
445 85 17...21C	1/2" 17-19-21 mm alu doppen, douilles à chocs
8044125MPP	verlengstuk, rallonge 125 mm
80541MPP	1/2" kniegewricht, cardan universel
681A300	wielsleutel 17-19-13/16" -1/2"
6474530W	1/2" momentsleutel, clé dynamométrique
6821	wielgewichttang
82544	slagmoersleutel, clé à chocs 1/2"



## FOR F4891 - Jumbo

### Slagmoerset 1/2" 89 delig

#### Jeu de douilles à chocs & acc. 1/2" 89 pcs

445 10...32 kort 1/2"	8-10-11-12-13-14-15-16-17-18-19-20-21-22-23-24-26-27-28-30-32-33-34-35-36 mm
44585 10...32 lang 1/2"	8-10-11-12-13-14-15-16-17-18-19-20-21-22-23-24-26-27-28-30-32-33-34-35-36 mm
445 85 17...21C	1/2" 17-19-21 mm alu doppen, douilles à chocs
8044125MPP	verlengstuk, rallonge 125 mm
24406004 tot 19 1/2"	inbus 4-5-6-7-8-10-12-14-17-19mm (6000M)
24606020 tot T70 1/2"	torx T20-T25-T27-T30-T40-T45-T50-T55-T60-T70 (60mmL)
24806008 tot 12 1/2"	spline M8-M10-12 (60mmL)
24807814 tot 18 1/2"	spline M14-M16-M18 (78mmL)
80541MPP	1/2" kniegewricht, cardan universel
8044125MPP	verlengstuk, rallonge 125mm
8044250MPP	verlengstuk, rallonge 250mm
80934MPB	adapter 3/8" x 1/2"
80964MPB	adapter 3/4" x 1/2"
6474470	1/2" momentsleutel 42-210 NM







	Doppensets - jeu de douilles 1/4"	86
	Doppen - douilles 1/4"	94
	Ratels - cliquets 1/4"	98
	Accessoires 1/4"	99
	Doppensets - jeu de douilles 3/8"	100
	Doppensets inch - jeu de douilles en pouce 3/8"	104
	Doppen - douilles 3/8"	106
	Ratels - cliquets 3/8"	109
	Accessoires 3/8"	108
	Doppensets - jeu de douilles 1/2"	110
	Doppensets inbus - jeu de douilles hex 1/2"	117
	Doppensets torx - jeu de douilles torx 1/2"	118
	Doppensets XZN - jeu de douilles XZN 1/2"	120
	Doppensets inch maten - jeu de douilles en pouce	121
	Doppen - douilles 1/2"	122
	Accessoires 1/2"	129
	Ratels - cliquets 1/2"	130
	Doppensets - jeu de douilles 3/4"	131
	Doppen & toebehoren - douilles 3/4"	132
	Doppensets - jeu de douilles 1"	134
	Accessoires 1"	135



## Doppensets - Jeu de douilles 1/4"

### FOR 2133-5

1/4" Doppenset 6 kant 13 delig op rail

1/4" *Jeu de douilles 6 pans 13 pcs sur rail*



525 04....14

4-4.5-5-5.5-6-7-8-9-10-11-12-13-14 mm

### FOR 21110-5

1/4" Lange 6 kant doppenset 11 delig op rail SAE

1/4" *Douilles longues 6 pans 11 pcs sur rail SAE*



5/32"- 3/16"-7/32"-1/4"-9/32"-5/16"-11/32"-3/8"-  
7/16"-1/2"-9/16"

### FOR 2133

1/4" Doppenset 12 kant 13 delig op rail

1/4" *Jeu de douilles 12 pans 13 pcs sur rail*



529 04....14

4-4.5-5-5.5-6-7-8-9-10-11-12-13-14 mm

### FOR 21115

1/4" Lange 6 kant doppenset 11 delig op rail

1/4" *Douilles longues 6 pans 11 pcs sur rail*



5255 004....14

4-5-6-7-8-9-10-11-12-13-14 mm

### FOR 21014

1/4" Lange 12 kant doppenset 10 delig op rail

1/4" *Douilles longues 12 pans 10 pcs sur rail*



5295 005....14

5-6-7-8-9-10-11-12-13-14 mm

### FOR 21016

1/4" Torx E doppen 10dlg op rail

*Jeu de douilles Torx E 1/4" 10pcs sur rail*



526 serie

1/4"

E4-E5-E6-E7-E8-E10-E11-E12-E14-E16

## FOR 20812

Torxset 1/4" 8 delig  
Jeu de Torx 1/4" 8pcs



32632 08....40	1/4"	T8-T10-T15-T20-T25-T27-T30-T40 (32 mm L)
----------------	------	---



## FOR 2111I

Torxset 1/4" - 3/8" 11 delig  
Jeu de Torx 1/4" - 3/8" 11 pcs



32632 10....30	1/4"	T10-T15-T20-T25-T27-30 (32 mm L)
33650 40....60	3/8"	T40-T45-T50-T55-T60 (50 mm L)



## FOR 2112I

Resistorxset 1/4" - 3/8" 11 delig  
Resistorx 1/4" - 3/8" 11 pcs



32732 10....30	1/4"	T10H-T15H-T20H-T25H-T27H-30H
33750 40....60	3/8"	T40H-T45H-T50H-T55H-T60H

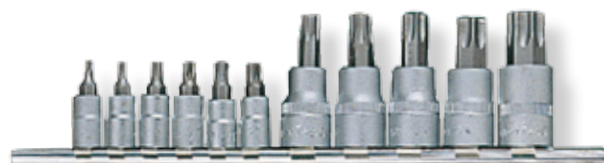

## FOR 20711

1/4" Resistorx 5 kant doppenset 7 delig op rail  
1/4" Resistorx 5 pans douilles 7 pcs sur rail



32F32 10.....40	TS10-TS15-TS20-TS25-TS27-TS30-TS40
-----------------	------------------------------------



## FOR 2073

1/4" Inbus doppenset 7 delig op rail  
1/4" Jeu de douilles hexagonales 7 pcs sur rail



32432 03...10	3-4-5-6-7-8-10 mm
---------------	-------------------



## FOR 2073S

1/4" Inbus doppenset inch 7 delig op rail  
1/4" Jeu de douilles hexagonales 7 pcs sur rail



32432 1.8.....3.8	1/2"-5/32"-3/16"-7/32"-1/4"-5/16"-3/8"
-------------------	--



## Doppensets - Jeu de douilles 1/4"

### FOR 2222

1/4" Doppenset 22 delig

1/4" Jeu de douilles 22 pcs

display stand (12 sets) - € 190.00



121251 ..... 3	PH1 - PH2 - PH3 (25 mm L)
12325 04 .... 065	plat 4-5-5-6.5 mm
12425 03....06	inbus 3-4-5-6 mm
12625 10....30	torx 10-T15-T20-T25-T30
525 06....13	6-7-8-10-13 mm dop 1/4" 6-kant
8092225	bit adapter 1/4" - 1/4"
802214	1/4" ratel, cliquet



### FOR 2292

1/4" Doppenset 29 delig geleverd in pvc koffer

1/4" Jeu de douilles 29 pcs 6 pans



5250 04...13	doppen 6k 4-4,5-5-5,5-6-7-8-9-10-11-12-13 mm
323 04...07	bit dop plat 4-5,5-7
324 03...08	hex 3-4-5-6-8
321 01...2	philips 1-2
322 01...2	pozidriv 1-2
8143	steekhecht, manche tournevis
8042050	verlengstuk - rallonge 50 mm
8032115	wringstaaf, manche en T
80222	ratel, cliquet
80521	kniegewricht, cardan universeel



### FOR 2421

1/4" Doppenset 42 delig geleverd in pvc koffer

1/4" Jeu de douilles 42 delig. 6 pans



	doppen 6 kant - douilles 6 pans
525 032....14	3,2-4,-4,5-5-5,5-6-7-8-9-10-11-12-13-14 mm
12425 03....08	Inbus 3,4,5,6,8 mm
12625 10....40	Torx T10-T15-T20-T25-T30-T40
12325 04....065	plat 4-5,5-6,5 mm
12125 1....3	philips PH-1-PH-2-PH-3
12225 1....3	pozidriv PZ,1-PZ-2-PZ,3
80229	ratel, cliquet
8042 050....150	2 verlengstukken, rallonges 50-150 mm
80521	kniegewricht, cardan universeel
81022	bit houder 1/4"x1/4"
8143	steekhecht, manche tournevis
80632	1 adapter voor verlengstuk 3/8"x1/4"
81225	magneet, aiment



## FOR 2312

1/4" Doppenset 12k 31 delig mm + inch in pvc koffer

1/4" Jeu de douilles 21 pans mm + en pouce en coffre PVC 31 pcs



529 004.....14	12 k doppen metric, douille 12pans en pouce 4-4,5-5-5,5-6-7-8-9-10-11-12-13-14 mm
529 3,16.....9,16	12k doppen Inch 3/16"-7/32"-1/4"-9/32"-5/16" 11/32"-3/8"-7/16"-1/2"-9/16"
80222	ratel, cliquet
8042 050.....150	verlengstukken, rallonges 50-150 mm
80622	adapter 1/4"*1/4"
80521	kniegewricht, cardan universeel
8145	steekhecht, manche tournevis
81022	1 bit houder, porte embout
8111	flexibel verlengstuk, rallonge flex



## FOR 2312-5

1/4" Doppenset 31 delig mm + inch in pvc koffer  
- idem maar 6 kant doppen



1/4" Jeu de douilles 31 pcs metric + en pouce en coffre PVC 6 pans

## FOR 2402

1/4" Doppenset 40 delig mm + inch in pvc koffer

1/4" Jeu de douilles 40 pcs mm et en pouce



525 04....13 6k	4-4,5-5-5,5-6-7-8-9-10-11-12-13 mm
525 3,16....1,2	3/16"-1/4"-9/32"-11/32"-3/8"-1/2" lange doppen, douilles longues 6p
52550 04....13	4-5-5,5-6-7-8-9-10-11-13 mm
52550 3,16....1,2	3/16"-1/4"-3/8"-1/2"
80225	ratel, cliquet
8042 050....150	verlengstuk, rallonge 50-75-150 mm
8111	flexibel verlengstuk, rallonge flex
8032115	T schuifstuk, manche en T
80521	kniegewricht, cardan universeel
8143	steekhecht, manche tournevis

